

E

ENGLISH

FCC STATEMENT

This device complies with Part 15 of the FCC Rules. Operation is subject to the following two conditions:

- (1) This device may not cause harmful interference, and
- (2) This device must accept any interference received, including interference that may cause undesired operation.

Note:

This equipment has been tested and found to comply with the limits for Class B digital devices, pursuant to Part 15 of the FCC rules. These limits are designed to provide reasonable protection against harmful interference in a residential installation. This equipment generates, uses and can radiate radio frequency energy and, if not installed and used in accordance with the instructions, may cause harmful interference to radio communications. However, there is no guarantee that interference will not occur in a particular installation. If this equipment does cause harmful interference to radio or television reception, which can be determined by turning the equipment off and on, the user is encouraged to try to correct the interference by one or more of the following measures:

- Reorient or relocate the receiving antenna
- Increase the separation between the equipment and receiver
- Connect the equipment into an outlet on a circuit different from that to which the receiver is connected
- Consult the dealer or an experienced radio/TV technician for help

Use of shielded cable is required to comply with Class B limits in Subpart B of Part 15 of the FCC rules. Do not make any changes or modifications to the equipment unless otherwise specified in the manual. If such changes or modifications should be made, you could be required to stop operation of the equipment.

TRADEMARK INFORMATION

- Microsoft® and Windows® are U.S. registered trademarks of Microsoft Corporation.
- Pentium® is a registered trademark of Intel Corporation.
- Macintosh is a trademark of Apple Computer, Inc.
- SD™ is a trademark.
- Other names and products may be trademarks or registered trademarks of their respective owners.

READ THIS FIRST

Notice:

1. Product design and specifications are subject to change without notice. This includes primary product specifications, software, software drivers, and user's manual. This User Manual is a general reference guide for the product.
2. The product and accessories that come with your camera may be different from those described in this manual. This is due to the fact that different retailers often specify slightly different product inclusions and accessories to suit their market requirements, customer demographics, and geographical preferences. Products very often vary between retailers especially with accessories such as batteries, chargers, AC adapters, memory cards, cables, carrying cases/pouches, and language support. Occasionally a retailer will specify a unique product color, appearance, and internal memory capacity. Contact your dealer for precise product definition and included accessories.
3. The illustrations in this manual are for the purpose of explanation and may differ from the actual design of your camera.
4. The manufacturer assumes no liability for any errors or discrepancies in this user manual.

WARNING

- Do not expose the camera to moisture and make sure no water gets into the camera. Take particular care when using the camera under extreme weather conditions, such as rain or snow, or when operating the camera at the beach or near water. Avoid using this camera in places subject to extreme moisture. Do not use the camera if water has entered the camera. Turn the camera off and remove the battery. Contact your dealer or authorized service facility. Do not continue to use the camera as this may cause a fire or an electrical shock.

- Do not use the camera if any foreign objects have entered the camera. Turn the camera off and remove the battery. Contact your dealer or authorized service facility. Do not continue to use the camera as this may cause a fire or an electrical shock.

- Do not place the camera in an unstable location such as on a wobbly table or sloping surface where the camera may fall or tip over and cause injury. If the camera has been dropped or damaged, turn the camera off and remove the battery. Contact your dealer or authorized service facility. Do not continue to use the camera as this may cause a fire or an electrical shock.

- Do not insert or drop metallic or other foreign objects into the camera through access points such as the memory card slot. This may cause a fire or an electrical shock.

- Do not attempt to modify this camera. Do not remove the camera casing. This may cause a fire or an electrical shock. Internal inspection and repairs should only be carried out by an authorized service facility.

- Never operate this camera in any way while driving a vehicle. This may cause a traffic accident.

- A camera is a precision instruments. Please do not drop it, strike it or use excessive force when handling the camera.

CAUTION

- Do not place this camera in a location affected by oil fumes or steam, such as near a cooking stove or humidifier. This may cause a fire or an electrical shock.

- Do not leave this camera in a location subject to extremely high temperatures, such as in a sealed vehicle or in direct sunlight. Exposure to high temperatures may adversely affect the camera case and internal components and may cause a fire.

- Do not cover or wrap the camera with a cloth or quilt. This may cause heat to build up and distort the camera case and cause a fire. Always use the camera and accessories in well-ventilated locations.

- Do not use the camera to look directly at the sun. There is a danger of injury to the eyes.

- Do not use battery other than those specified for use with your camera. Use of unsuitable battery may result in the battery splitting, or leaking and may cause a fire, injury, or soiling of the battery compartment.

- When placing the battery into the camera, check the polarity markings on the battery (- and +) to ensure that the battery is inserted correctly. Incorrect battery polarity will result in camera inoperability and may result in the battery splitting or leaking and causing a fire, injury, or soiling of the battery compartment.

- When the camera is left at low or high temperatures do not touch it with your bare hands. It is possible that you may sustain an injury due to burning.

CONTENTS

8 INTRODUCTION

- 8 Overview
- 10 Package Contents



11 GETTING TO KNOW THE CAMERA

- 11 Front View
- 12 Rear View
- 14 Viewfinder LED Indicator
- 15 LCD Monitor Icons

17 GETTING STARTED

- 17 Attaching the Camera Strap
- 18 Inserting and Removing the Battery
- 19 Charging the Battery
- 21 Inserting and Removing the SD Card
- 22 Turning the Power On/Off
- 23 Setting the Date and Time
- 24 Choosing the Language
- 25 Formatting the SD Card
- 26 Setting Image Resolution and Quality

28 PHOTOGRAPHY MODE

- 28 [] Still Image Mode
- 30 Recording Voice Memos
- 31 Using the Optical Zoom
- 32 Using the Digital Zoom
- 33 Setting the Flash
- 35 Setting the Focus
- 36 Setting the Self-timer
- 37 Exposure Compensation/Backlight Correction
- 39 [] Movie Mode

40 [] PLAYBACK MODE

- 40 Playing Back Still Images
- 41 Playing Back Video Clips
- 43 Playing Back Still Images/Video Clips on a TV
- 44 Attaching Voice Memos
- 45 Thumbnail Display
- 46 Zoom Playback
- 47 Slideshow Display
- 48 Protecting Images
- 50 DPOF Settings
- 52 [] Erasing Images

54 MENU OPTIONS

- 54 Still Image Menu (Picture)
- 57 Still Image Menu (Function)
- 60 Movie Menu (Picture)
- 61 Movie Menu (Function)
- 62 Playback Menu
- 63 Setup Menu (In Photography Mode)
- 65 Setup Menu (In Playback Mode)

67 TRANSFERRING RECORDED IMAGES AND VIDEOS TO YOUR COMPUTER

- 68 Step 1: Installing the USB Driver
- 69 Step 2: Connecting the Camera to Your Computer
- 70 Step 3: Downloading Images and Video Files

71 INSTALLING PHOTOSUITE

72 INSTALLING PHOTOVISTA

73 CONNECTING THE CAMERA TO OTHER DEVICES

74 CAMERA SPECIFICATIONS

INTRODUCTION

Overview

Congratulations on your purchase of the new digital camera.

Capturing high-quality digital pictures is fast and easy with this state-of-the-art smart camera. Equipped with a 4.2 Mega pixels CCD, this camera is capable of capturing pictures with a resolution of up to 2272 x 1704 pixels.

Other cool features provided by the camera include the following:

- | | |
|----------------------------------|--|
| LCD monitor - | 2.0" LTPS TFT color LCD monitor makes it easy to frame your subject when taking pictures. It also displays the pictures you have taken. |
| Recording media - | External memory supports SD card up to 512MB. |
| Optical zoom - | 3x optical lens allows you to take telephoto and wide-angle pictures. |
| Digital zoom - | 3.6x digital zoom and 3x optical zoom permit zoom photography of up to 10.8 times; 2x and 4x playback captured images to enlarge a selected portion of an image. |
| Flexible flash settings - | Change the flash setting according to your lighting environment and photography mode setting. |
| Focus mode - | Photographs can be taken with the distance to the subject set by auto focus, macro or infinity. |
| Self-timer mode - | Time selectable between 10 seconds, 2 seconds and 10+2 seconds. |
| Capture mode - | Take different still images including single, a series of 3 images with different exposures, and 3 images continuously. |
| Movie mode - | Record video clips with voice. |

- Voice memo -** A voice memo can be recorded once for 30 seconds at photography mode immediately following a still image captured or at playback mode while viewing the picture.
- Camera settings -** Have more control over picture quality by adjusting the menu options.
- Thumbnail display -** Display in sets of nine pictures on the LCD monitor for easier and quicker selection of pictures.
- TV and PC connection -** View pictures on a television monitor or computer while connected to the USB or A/V cable.
- DPOF settings -** Allow you to embed printing information on your SD card and to print your images on a DPOF compatible printer by simply inserting it.

Package Contents

Carefully unpack your camera and ensure that you have the following items.

Common Product Components:

- Konica Minolta DiMAGE E40 Digital Still Camera
- Hand Strap
- USB Cable
- AV Cable
- SD Memory Card
- Lithium-ion Battery
- Battery Charger/AC Adapter
- Camera Case
- CD-ROM

Common (Optional) Accessories:

- Rechargeable lithium-ion battery

Please contact your local camera dealer or the Konica Minolta distributor in your area.

GETTING TO KNOW THE CAMERA



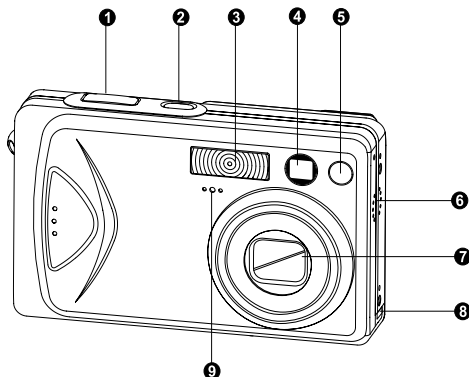



Front View

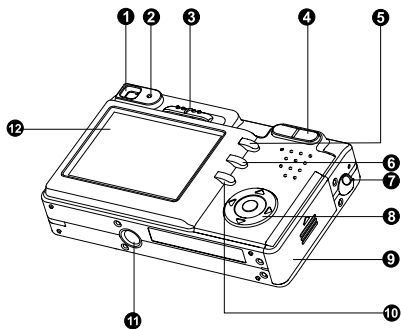

| # | Name | Description |
|----|-------------------------------------|---|
| 1. | Shutter button | Focuses and locks the exposure of the camera when pressed halfway down, and takes the picture when pressed all the way down. |
| 2. | ON/OFF button | Turns the camera power on and off. |
| 3. | Flash | Provides flash illumination. |
| 4. | Viewfinder window | Allows you to frame the subject of the picture. |
| 5. | Self-timer LED (AF auxiliary light) | Blinks red during Self-timer mode until picture is taken. |
| 6. | Speaker | Produces camera sounds and plays recorded audio. |
| 7. | Lens | 3x optical zoom lens allows you to take telephoto and wide-angle pictures. |
| 8. | Conversion adapter terminal | Allows you to connect the conversion adapter to an AC power adapter to the camera to operate the camera without battery, or to charge rechargeable lithium-ion battery or to connect a USB cable or an A/V cable to the camera. |
| 9. | Microphone | Records audio clips. |

Rear View



| # | Name | Description |
|-----|--|--|
| 1. | Viewfinder | Allows you to frame the subject of the picture. |
| 2. | Viewfinder LED | Displays the camera current state. |
| 3. | Mode switch | Sets the camera mode. |
| |  | Selects this when taking still images. |
| |  | Selects this when recording video clips. |
| |  | Performs image playback and deletion. |
| 4. |  Zoom in button | Zooms the lens to telephoto position. |
| |  Zoom out button | Zooms the lens to wide-angle position. |
| 5. | MENU button | Toggles OSD menu on and off. |
| 6. |  Erase button | Allows you to erase the picture. |
| 7. | Strap holder | Camera strap attachment. |
| 8. | SET /Direction button | Allows you to scroll through menus and pictures, and then select choices. |
| 9. | Battery/SD card cover | Allows access to the battery and insert or remove the memory card. |
| 10. |  Display button | Turns the LCD monitor display and live view on and off. |
| 11. | Tripod socket | Allows tripod mounting. |
| 12. | LCD monitor | Provides menu information to operate the camera, and previews the picture before taking it and review it afterwards. |

SET /Direction button

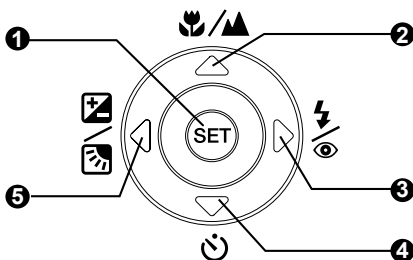

| # | Name | Description |
|----|--|--|
| 1. | SET button | Enters the menu page and confirms the chosen setting. |
| 2. | ▲ button 🌸/▲ Focus button | Scrolls upwards. Allows you to choose the appropriate focus setting. |
| 3. | ▶ button ⚡/👁️ Flash button | Scrolls right. Allows you to choose the appropriate flash setting. |
| 4. | ▼ button 🕒 Self-timer button | Scrolls downwards. Allows you to toggle the self-timer on and off, selects the desired self-timer mode. |
| 5. | ◀ button ☑️/☑️ Exposure compensation / Backlight correction button | Scrolls left. Allows you to toggle the exposure compensation / backlight correction on and off. |





























Viewfinder LED Indicator

This describes the color and state of the viewfinder LED.

| Color | State | During power off | During photography | During connection to a PC |
|--------|----------|-----------------------------------|--|--|
| Green | On | The completion of battery charge. | AE or AF is locked with the shutter button held halfway. | - |
| | Flashing | Battery charging in progress. | - | - |
| Red | On | Battery charging error. | Writing to SD card in progress. | In communication to PC. (SD card is inserted.) |
| | Flashing | - | When the image is not in focus. | - |
| Orange | On | - | Charging of the flash in progress. | - |
| | Flashing | - | Hardware malfunction. | SD card is not inserted. |

LCD Monitor Icons

Photography mode []

1. Zoom status
2. Voice memo
3. Remaining battery status
 - [] Full battery power
 - [] Medium battery power
 - [] Low battery power
 - [] No battery power
4. Flash icon
 - [Blank] Auto
 - [] Red-eye Reduction
 - [] Forced Flash
 - [] Suppressed Flash
 - [] Night Scene
5. [] Histogram
6. Focus area (When the shutter button is pressed halfway.)
7. Capture mode icon
 - [Blank] Single
 - [] Continuous
 - [**AEB**] Auto Exp.
8. Image size
 - [] 2272 x 1704
 - [] 1600 x 1200
 - [] 1280 x 960
 - [] 640 x 480
9. Possible number of shots
10. Quality
 - [*******] Fine
 - [******] Standard
 - [*****] Economy
11. Date and time
12. Self-timer icon
 - [] 10 sec.
 - [] 2 sec.
 - [] 10+2 sec.
13. Unsteady hold warning icon
14. [] Exposure compensation
[] Backlight correction
15. Metering icon
 - [**Blank**] Multi
 - [] Spot
16. White balance icon
 - [Blank] Auto
 - [] Incandescent
 - [] Fluorescent 1
 - [] Fluorescent 2
 - [] Day Light
 - [] Cloudy
 - [] Manual
17. Focus icon
 - [Blank] Auto focus
 - [] Macro
 - [] Infinity
18. [] Still image mode

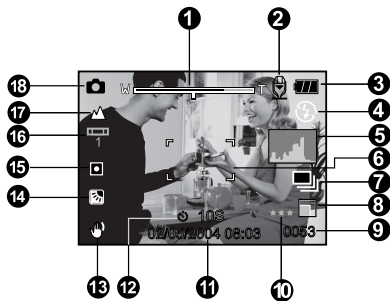

NOTE

- Each press of the [] button switches one step in the sequence of Normal display (displaying the icons, etc), Normal and Histogram, display OFF, LCD monitor OFF.

Photography mode [📷]

1. [📷] Movie mode
2. Zoom status
3. Remaining battery status
4. Image size
5. Possible recording time / elapsed time
6. Quality
7. Recording indicator
8. Self-timer icon
9. Focus icon

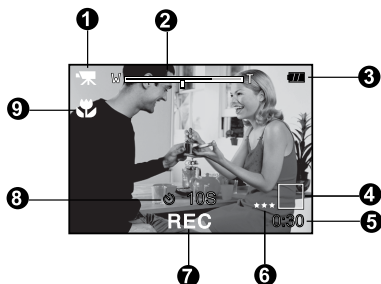

Playback mode [🖼️] -Still image playback

1. Mode icon
2. File number
3. Folder number
4. Protect icon
5. Voice memo

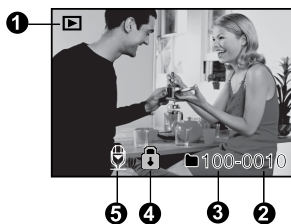

Playback mode [🎥]-Video playback

1. Video status bar
2. Elapsed time
3. File number
4. Folder number
5. Protect icon
6. Mode icon
7. Play mode
8. Sound off icon (When the [🔊] button is pressed during video playback.)
9. Total time

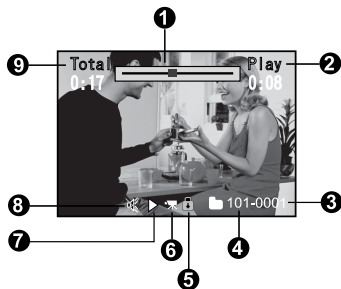

GETTING STARTED

Attaching the Camera Strap

Attach the camera strap as shown in the illustration.

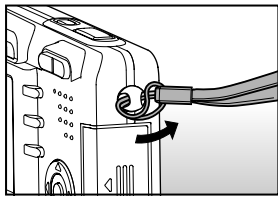
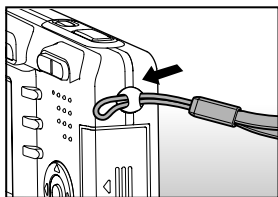

Inserting and Removing the Battery

We highly recommend using specified rechargeable lithium-ion battery (3.7V) to fully demonstrate this camera's function. Charge the battery before using the camera. Make sure that the power of the camera is off before inserting or removing the battery.

Inserting the Battery

1. Open the battery/SD card cover.
2. Insert the battery in the correct orientation shown.
 - Tilt the battery lock lever in the direction of the arrow and orient the battery so that its label is facing to the rear side of the camera, and then insert the battery.
3. Close the battery/SD card cover.

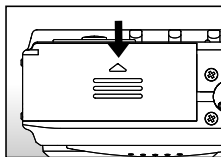
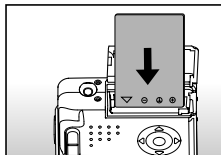
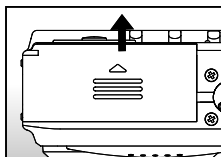

Removing the Battery

Open the battery/SD card cover and then release the battery lock lever. When the battery has come out a little, slowly pull it out the rest of the way.



NOTE

- If you are not going to use the battery for an extended period of time, remove it from the camera to prevent leakage or corrosion.
- Avoid using the battery in extremely cold environments as low temperatures can shorten the battery life and reduce the camera performance.
- The battery may feel warm when using the camera for an extended period of time or using the flash continuously. This is normal and not a malfunction.
- The camera may feel warm when being used continuously or for an extended period of time. This is normal and not a malfunction.

Charging the Battery

New battery or the battery that has not been used for an extended period of time (the battery that passed the expiry date is an exception) might affect the number of pictures that can be taken. Therefore, to maximize its performance and lifetime, we recommend that you fully charge the battery and discharge it for at least one complete cycle before use. Using the Battery Charger/AC Adapter charges the battery. Make sure that the power of the camera is off and then insert the battery before starting.

1. Insert the conversion adapter into the conversion adapter terminal of the camera as shown in the illustration.

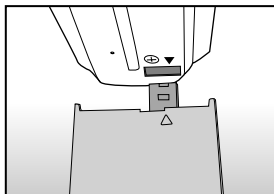

2. Insert one end of the Battery Charger/AC Adapter into the DC IN terminal of the conversion adapter.
3. Insert the other end of the Battery Charger/AC Adapter into a wall outlet.

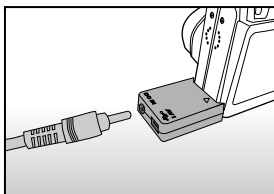

- The viewfinder LED flashes green when charging is started and lights green when charging is completed. It lights red when a charging error occurs.
- It is recommended to fully discharge or exhaust the battery before being charged.
- Charging time varies according to the ambient temperature and the status of battery.
- If you want to use the camera when the battery charging is in progress, use the camera with the Battery Charger/AC Adapter connected.



NOTE

- This camera must be used with specified Battery Charger/AC Adapter. Damage caused by the use of an incorrect adapter is not covered under the warranty.
- When the charging is not started even if following the above procedure, turn the power on at any mode after LCD monitor turns on, and then turn the power off.
- The battery may feel warm after it has been charged or immediately after being used. This is normal and not a malfunction.
- When using the camera in cold areas, keep the camera and battery warm by holding them inside your outer cloth.
- If you open the battery cover without removing the battery, the power will not be terminated. If you remove the battery, you have to insert the battery again in a period of 2 hours in order to make sure that the date and time will not be reset.

Inserting and Removing the SD Card

Images photographed with this camera will be stored on the SD card. Without inserting the SD card, you cannot take photographs using the camera. Before inserting or removing the SD card, make sure that the power of the camera is off.

Inserting the SD card

1. Open the battery/SD card cover.
2. Insert the SD card in the correct orientation shown.
 - Hold the SD card with its front side of the SD card (printed arrow) facing the rear side of the camera, and then insert the card as far as it can go.
3. Close the battery /SD card cover.

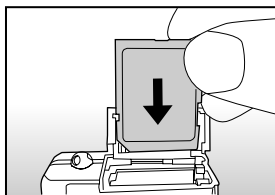

Removing the SD card

Open the battery/SD card cover, press lightly on the edge of the SD card and it will eject.



NOTE

- If the camera is powered on without an SD card inserted into the camera, the "NO CARD" message appears on the LCD monitor.
- To prevent valuable data from being accidentally erased from an SD card you can slide the write-protected tab (on the side of the SD card) to "LOCK".
- To save, edit or erase data on an SD card, you must unlock the card.
- This camera does not support MultiMediaCard™.

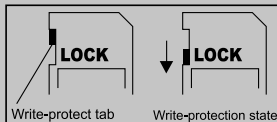

Turning the Power On/Off

Load the battery and insert an SD card before starting.

Turning the power on

Press the ON/OFF button to turn the power on.

- The viewfinder LED lights green and the camera is initiated.
- When the power is turned on, the camera will start in the mode that was set.

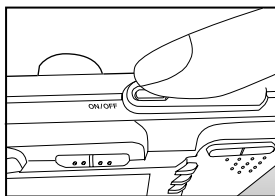

Turning the power off

Press the ON/OFF button to turn the power off.



NOTE









- The power is turned off automatically when the camera has not been operated for a fixed period time. To resume the operation condition, turn the power on again. Refer to section in this manual titled "**Auto OFF**" in the **Setup Menu (In Photography Menu)** for further details.
- After the power is turned on, it may take several seconds to charge the flash. While the flash is being charged, the viewfinder LED lights orange, and then the camera is not yet ready for photography. Start photography after the viewfinder LED is turned off.

Setting the Date and Time

The date/time needs to be set if/when:

- Camera is turned on for the first time.
- Camera is turned on after leaving the camera without the battery for an extended period of time.

When the date and time information is not displayed on the LCD monitor, follow these steps to set the correct date and time.

1. Slide the mode switch to [] or [].
2. Press the **MENU** button and select [Setup] menu with the  button
3. Select [Date/Time] with the  /  buttons and press the **SET** button.
 - The Date/Time setting screen will be displayed.
4. Select the item's field with the  /  buttons and adjust the value for the date and time with the  /  buttons.
 - The date and time is set in the order year-month-day-hour-minute.
 - The time is displayed in 24-hours format.
5. After confirming all settings are correct, press the **SET** button.
 - The setting will be stored and the screen will return to the set-up menu.

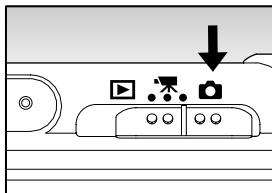



| Picture | Function | Setup |
|--------------|---------------|----------------------|
| Beep | Fr. No. Reset | ON Next Menu |
| Date/Time | Auto OFF | Next Menu 1 Min |
| Sys. Reset | Language | Next Menu English |
| Menu:Exit | | ◀ or ▶ Select Page |
| Set : Adjust | | ▲ or ▼ Select Item |

| Picture | Function | Setup |
|--------------|----------|---------------------|
| Date / Time | | |
| ▲ | 2004 | 01 |
| ▼ | | 01 |
| | 01 | 01 |
| Menu:Exit | | ◀ or ▶ Select Item |
| Set : Adjust | | ▲ or ▼ Change Value |

Choosing the Language

Specify in which language menus and messages are to be displayed on the LCD monitor.

- Slide the mode switch to [] or [] or [].
- Press the **MENU** button and select [Setup] menu with the **▶** button.
 - If no images/video clips are recorded on the SD card, press the **MENU** button and then [Setup] menu is displayed.
- Select [Language] with the **▲** / **▼** buttons and press the **SET** button.
 - The Language setting screen will be displayed.
- Select the displayed language with the **▲** / **▼** buttons and press the **SET** button.
 - The setting will be stored.





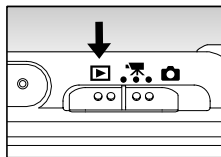

Formatting the SD Card

This erases all of the images and folders that have been recorded on the SD card. Formatting is not possible when the SD card is in the locked condition.

1. Slide the mode switch to [].



2. Press the **MENU** button.
 - [Setup] menu is displayed.
 - If images/video clips are recorded on the SD card, press the  button after the **MENU** button is pressed.
3. Select [Format] with the  /  buttons, then press the **SET** button.
4. Select [Execute] with the  /  buttons, and press the **SET** button.
 - To cancel formatting, select [Cancel] and press the **SET** button.

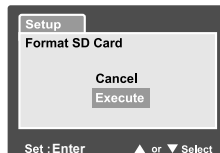
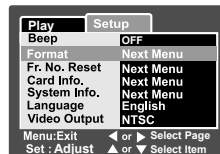

NOTE

- You need to format an SD card by this camera before using it.
- Formatting the SD card also erases the protected images. All data other than images are also erased. Before formatting the card, make sure that all the images are unnecessary.
- Formatting is an irreversible action and data cannot be recovered at a later time.
- An SD card having any problem cannot be properly formatted.



Setting Image Resolution and Quality

Resolution and quality settings determine the pixel size (dimension), image file size, and compression ratio for your images. These settings affect the number of images that can be stored on a memory card. As you get to know the camera, it is recommended that you try each quality and resolution setting to get an appreciation for the effects that these settings will have on your images.

Higher resolution and higher quality images offer the best photographic results but produce large file sizes. Therefore, few images will take up a lot of memory space.

High resolution and quality settings are recommended for printed output and situations requiring the finest detail. Lower resolution/quality images take up less memory space and may be quite suitable for sharing images via e-mail, in a report, or on a web page.

To change image resolution or image quality, perform these steps below:

- Slide the mode switch to [] or [].
- Press the **MENU** button.
 - [Picture] of the photography menu is displayed.
- Select [Size] with the **▲** / **▼** buttons, and press the **SET** button.
- Select the desired setting with the **▲** / **▼** buttons, and press the **SET** button.
- Select [Quality] with the **▲** / **▼** buttons, and press the **SET** button.
- Select the desired setting with the **▲** / **▼** buttons, and press the **SET** button.
- To exit from the photography menu, press the **MENU** button.

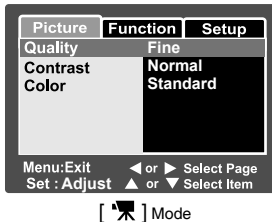
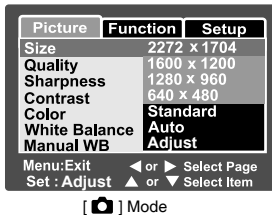





NOTE

- In the [] mode, size setting is not possible.

Possible number of shots (still image)

The table shows the approximate shots that you can take at each setting based on an optional SD card.

| Image size | Quality | SD card capacity | | | | |
|--|-------------|------------------|------|-------|-------|-------|
| | | 32MB | 64MB | 128MB | 256MB | 512MB |
|  (4M) 2272 x 1704 | *** Fine | 17 | 34 | 70 | 140 | 283 |
| | ** Standard | 28 | 58 | 118 | 236 | 476 |
| | * Economy | 52 | 107 | 217 | 433 | 872 |
|  (2M) 1600 x 1200 | *** Fine | 37 | 76 | 153 | 306 | 616 |
| | ** Standard | 59 | 121 | 244 | 487 | 981 |
| | * Economy | 118 | 242 | 489 | 975 | 1963 |
|  (1M) 1280 x 960 | *** Fine | 57 | 117 | 237 | 472 | 952 |
| | ** Standard | 94 | 193 | 391 | 780 | 1571 |
| | * Economy | 189 | 387 | 783 | 1560 | 3142 |
|  (VGA) 640 x 480 | *** Fine | 145 | 298 | 602 | 1200 | 2417 |
| | ** Standard | 210 | 430 | 870 | 1734 | 3491 |
| | * Economy | 379 | 775 | 1566 | 3121 | 6284 |

Possible recording time / sec (video clip)

| Image size | Quality | SD card capacity | | | | |
|--|-------------|------------------|-------|-------|-------|-------|
| | | 32MB | 64MB | 128MB | 256MB | 512MB |
|  320 x 240 | *** Fine | 01:45 | 03:34 | 07:13 | 14:23 | 28:59 |
| | ** Standard | 02:36 | 05:20 | 10:46 | 21:28 | 43:13 |

- * The data shows the standard testing results. The actual capacity varies according to the shooting conditions and settings.



NOTE

- The memory card testing results are based on Toshiba, Panasonic and SanDisk SD card.

PHOTOGRAPHY MODE

[] Still Image Mode

Auto photography is a typical method of photography. Photographs can be taken simply because the exposure (the combination of shutter speed and aperture setting) is controlled automatically to suit the photographic conditions. You can use both a viewfinder and a 2.0" LCD monitor to compose the images. Taking photographs using the viewfinder will conserve the battery power. If the battery power is low, it is recommended that you only compose images using the viewfinder. Using the LCD monitor, you can compose images more accurately, but at the cost of the battery consumption.

Using the Viewfinder

Make sure that the battery and SD card are inserted before taking photographs.

1. Press the ON/OFF button to turn the power on.
2. Slide the mode switch to [] .

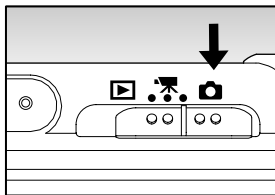

3. Compose your image in the viewfinder.

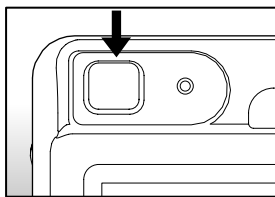

4. Press the shutter button.

- Pressing the shutter button down halfway automatically focuses and adjusts the exposure, and pressing the shutter button down fully takes the photographs.
- The focus area frame turns blue and the viewfinder LED lights green when the camera is in focus and the exposure is calculated.
- When the focus or exposure is not suitable, the frame of the focus area turns yellow and the viewfinder LED flashes red.
- If the photographic preview is set to "ON", the preview image (captured image) will be displayed while the image is being recorded onto the SD card.

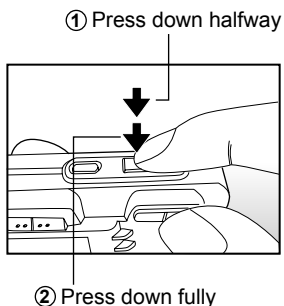

Using the LCD Monitor

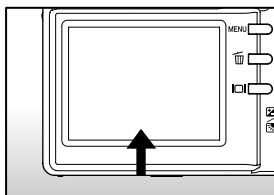

Make sure that the battery and SD card are inserted before taking photographs.

1. Press the ON/OFF button to turn the power on.
2. Slide the mode switch to [].
 - By default, the LCD monitor setting is on.
3. Compose your image in the LCD monitor.
4. Press the shutter button down halfway, then press it down fully.



Recording Voice Memos

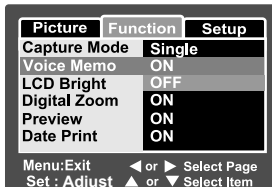

A voice memo can be recorded once for 30 seconds at still image mode immediately following a still image captured or at playback mode while viewing the picture.

- Slide the mode switch to [].
- Press the **MENU** button, and select the [Function] menu with the **▶** button.
 - [Function] of the still image menu is displayed.
- Select [Voice Memo] with the **▲** / **▼** buttons, and press the **SET** button.
- Select [ON] with the **▲** / **▼** buttons, and press the **SET** button.
- Press the **MENU** button to exit from the still image menu.
 - [] icon is displayed on the screen.
- Compose the picture, press the shutter button down halfway, then press it down fully.
 - [VOICE RECORDING] is displayed on the screen immediately, and the voice memo recording starts.
- Press the shutter button one more time during recording, or wait for 30 seconds
 - [VOICE RECORD END] will be displayed and the recording will end.
 - A [] icon is displayed with images that have been recorded with a voice memo.



Using the Optical Zoom





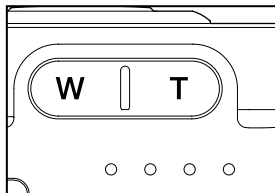



Zoom photography allows you to take zoom photographs up to 3 times the size or wide-angle photography depending on the distance up to the subject. You can also enlarge the center of the screen and take photographs in the digital zoom mode.

1. Slide the mode switch to [] or [].
2. If required, turn on the LCD monitor by pressing the  button.
3. Compose the picture with the zoom button.
 - Pressing the **T** button zooms in on the subject, and enlarges the subject on the LCD monitor.
 - Pressing the **W** button provides a wider angle picture.
 - The lens position moves according to the zoom button setting.
4. Press the shutter button down halfway, then press it down fully.



Using the Digital Zoom

Using a combination of 3 times optical zoom and 3.6 times digital zoom permits zoom photography of up to 10.8 times to suit the subject and the distance. The digital zoom is a compelling feature, the more an image is enlarged (zoomed), the more pixilated (grainer) the image will appear.

1. Slide the mode switch to [] or [].
2. Turn on the LCD monitor by pressing the  button.
3. To enable the digital zoom:
 - a. Press the **MENU** button.
 - b. Select [Function] with the  /  buttons.
 - c. Select [Digital Zoom] with the  /  buttons, and press the **SET** button.
 - d. Select [ON] with the  /  buttons again, and press the **SET** button.
 - e. Press the **MENU** button to exit from the menu screen
 - f. To activate the digital zoom, press and hold the **T** button completely until the image on the LCD monitor expands.

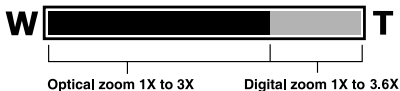

4. Press the shutter button to capture a “zoomed” image.







NOTE

- The digital zoom is cancelled when the  button is pressed and the LCD monitor is turned off.
- The zoom setting is automatically cancelled by either turning the camera off or the activation of the Auto OFF function.



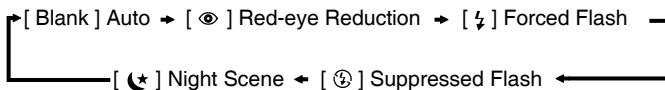
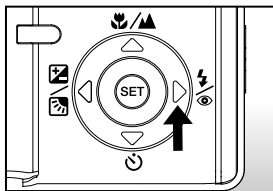

Setting the Flash

Set the flash for taking photographs. The flash firing mode can be set to suit for the photographic conditions.

1. Slide the mode switch to [].
2. Toggle the  /  button to select the desired flash mode.
 - Each press of the  /  button moves the icon one step through the sequence and displays it on the screen.





The table below will help you choose the appropriate flash mode:



| Flash mode | Description |
|---|--|
| [Blank] Auto | The flash fires automatically to suit the photographic conditions. |
| [] Red-eye Reduction | Use this mode to reduce the red-eye phenomenon when you want to take natural-looking photographs of people and animals in low-light conditions. When taking photographs, the red-eye phenomenon can be reduced by asking the subject (person) to look at the camera or get as close to the camera as possible. The flash always fires twice, and the photograph is taken at the second firing. |
| [] Forced Flash | In this mode, the flash always fires. Use this mode for photographing under artificial light such as backlighting, fluorescent lighting, etc. |
| [] Suppressed Flash | Use this mode when taking pictures using indoor lighting, for stages and indoor competitions, and when the subject is too far away for the flash to be effective. |
| [] Night Scene | Use this mode when taking pictures of people at dark or night-time background. When the Night Scene is selected, the flash mode is fixed to Slow Synchronization. (the flash is fired at a slower shutter speed.) |







NOTE

- In the [] focus mode and capture mode [Continuous] and [Auto Exp.], the flash mode is fixed to [] Suppressed Flash.
- The flash cannot be set in the [] mode.

Setting the Focus



Photographs can be taken with the distance to the subject set by auto focus, [] macro or [] infinity.

The settings will be maintained even when the power is turned off or when Auto OFF is activated.

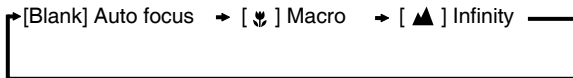
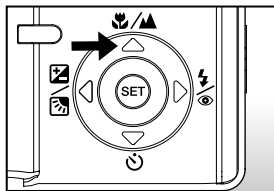
- Slide the mode switch to [] or [].
- Toggle the  button to select the desired focus mode.
 - Each press of the  button moves the icon one step through the sequence and displays it on the screen.



The table below will help you choose the appropriate focus mode:

| Focus mode | Description |
|--|--|
| [Blank]Auto Focus | Selects this when you want to leave the settings up to the camera so that you can take photographs without paying attention to settings. Approximately 50 cm to infinity (both Wide and Tele) |
| [] Macro | Selects this when you want to takes a close up photography. Wide (zoom off) : Approximately 6 cm to infinity Tele (at optical zoom 3x) : Approximately 35 cm to infinity |
| [] Infinity | Selects this when you want to take photographs of subjects at a distance of infinity. |

Setting the Self-timer

This setting allows photographs to be taken with the self-timer.

- Slide the mode switch to [] or [].
- Toggle the button to select the setting.
 - Each press of the button moves the icon one step through the sequence and displays it on the screen.

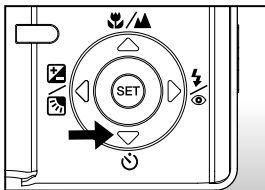

OFF → [10s] 10 sec. → [2s] 2 sec.
 [10+2s] 10+2 sec. ←

- For the [] mode and capture mode ([Continuous] and [Auto Exp.])

OFF → [10s] 10 sec. → [2s] 2 sec.

- Compose the picture, press the shutter button down halfway, then press it down fully.
 - The self-timer LED flashes and the photograph is taken after the preset time has elapsed.
 - The countdown is displayed on the LCD monitor.
 - To cancel the self-timer during operation, press the **SET** button.

The table below will help you choose the appropriate self-timer mode:

| Self-timer mode | Description |
|----------------------|---|
| [10s] 10 sec. | The picture is taken about 10 seconds after the shutter button is pressed. |
| [2s] 2 sec. | The picture is taken about 2 seconds after the shutter button is pressed. |
| [10+2s] 10+2 sec. | One picture is taken about 10 seconds after the shutter button is pressed, and the other photograph is taken again after 2 seconds. This is convenient when taking group photographs in succession. |







NOTE

- The self-timer setting is automatically cancelled after a photograph is taken.



Exposure Compensation/Backlight Correction

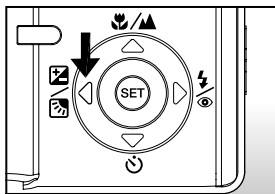

Photographs can be taken with the overall screen intentionally made brighter or darker. These settings are used when a suitable brightness (exposure) cannot otherwise be obtained in circumstance where the difference in brightness between the subject and the background (the contrast) is large, or when the subject that you want to photograph is very small within the screen. Exposure can be set in 0.3 EV units.

- Slide the mode switch to [] and press the  button.

- Each press of the  button displays the setting in the order of [Blank], [], [] Exposure Compensation.



- Set the exposure value with the  /  buttons.

- Press the  button to increase the value.
- Press the  button to decrease the value.
- The setting range of the exposure compensation is as follows.
-2.0, -1.7, -1.3, -1.0, -0.7, -0.3, 0, +0.3, +0.7, +1.0, +1.3, +1.7, +2.0
- The larger the value, the brighter the image. The smaller the value, the darker the image. The set value is displayed on the screen.

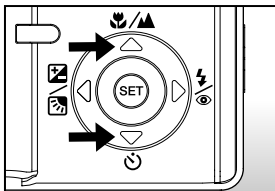

Effective Subjects and Set Values

- + (positive) compensation
 - * Printed matter comprising black text on whitish paper
 - * Backlighting
 - * Bright scenes or strong reflected light such as ski slopes
 - * When the sky accounts for a large area on the screen

- - (negative) compensation
 - * People illuminated by a spotlight, in particular, against dark background
 - * Printed matter comprising white text on blackish paper
 - * Weak reflecting bodies such as evergreen trees or darkish leaves

- Backlight correction (+1.3, fixed)
 - * When the background is bright and the subject is dark.
 - * When subjects (people) have a light source such as the sun to their backs.

[] Movie Mode

This mode allows you to record video clips at a resolution of 320 x 240 pixels. Voice can also be recorded.

1. Slide the mode switch to [].
2. Compose the picture with the zoom button.
 - Optical zoom and digital zoom can be set while composing.
3. Fully pressed the shutter button.
 - The recording of the video clip will start.
 - Pressing the shutter button one more time will end the recording of the video clip, and record the image into the SD card.
 - The recording time depends on the storage size and the subject of the image to be recorded.





NOTE

- In the [] mode, the LCD monitor cannot be turned off.
- When recording a video clip, flash photography is not possible.
- While the image is being recorded into the SD card, do not open the battery/SD card cover, nor remove the battery or SD card. Doing so might damage the SD card or destroy the data of the SD card.

[] PLAYBACK MODE

Playing Back Still Images

You can play back the still images on an LCD monitor. Insert the SD card into the camera and turn on the power before starting.

- Slide the mode switch to [].
 - The last image appears on the screen.
- The images can be fed in reverse or fed forward with the  /  buttons.

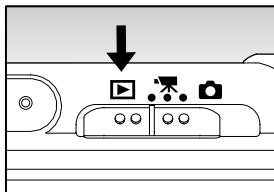

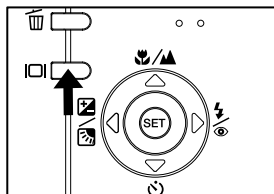







Image Display Information

You can switch the state of the information display by pressing the  button when playing back images. Each press of the  button switches the information display state in the following order:



NOTE

- Pressing the  /  buttons during image playback will result in a 90 degree rotated display. The  button rotates the image clockwise and displays it, whereas the  button rotates the image counterclockwise and displays it. A press of the button opposite to the direction in which the image was rotated will return the image to the normal display.
- A  icon is displayed with the video data. Video clips cannot be rotated.
- A  icon is displayed with images which have an audio memo recorded.
- Press the **SET** button to playback the voice memo data.
- The condition of the information display cannot be switched with video clips.

Playing Back Video Clips

You can play back video clips recorded on the camera. You can also play back voice.

1. Slide the mode switch to [].
 - The last image appears on the screen.
2. Select the desired video clip with the ▲ / ▼ buttons.
3. Press the **SET** button.
 - A press of the ► / ◀ buttons during playback allows fast forward play / fast reverse play.
 - To stop video playback:
Press the ▼ button.
This stops playback and returns to the start of the video clip.
 - To pause video playback
Press the **SET** button.
This pauses video playback.
To cancel pause, press the **SET** button again.

Button Operations

| | During Playback | During a Pause | During a Stop |
|---------------|---|-------------------------|----------------------------------|
| ▶ button | <p>Forward play</p> <p>Each press of the ▶ button moves the operation one step in the sequence of 2 times fast forward play, 4 times fast forward play, and regular play.</p> | 1-frame feed | |
| ◀ button | <p>Reverse play</p> <p>Each press of the ◀ button moves the operation one step in the sequence of 2 times fast reverse play, 4 times fast reverse play, and regular play.</p> | Reverse 1-frame feed | |
| ▲ button | Sound On/Off | Sound On/Off | The previous image is displayed. |
| ▼ button | Stop (The display returns to the 1st frame playback) | | The next image is displayed. |
| SET button | Pause | Canceling pause | Regular forward play |



NOTE

- Video clips cannot be displayed rotated or enlarged.

Playing Back Still Images/Video Clips on a TV

You can also playback your images on a TV screen. Before connecting to any devices, make sure to select NTSC / PAL system to match the video output system of the video equipment you are going to connect to the camera, then turn all connected devices off. It is also recommended to use the AC power adapter while transferring the recorded images and video files.

1. Slide the mode switch to [].
2. Connect one end of the A/V cable to the conversion adapter terminal of the camera.

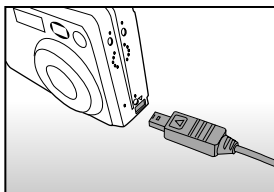

- If you use the conversion adapter to connect the A/V cable, insert the conversion adapter into the conversion adapter terminal of the camera first, and then connect one end of the A/V cable to the A/V terminal of the conversion adapter.

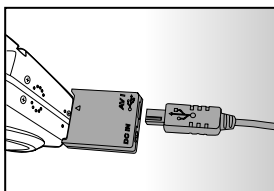

3. Connect the other end to the A/V input socket of the TV set.
4. Turn the TV and camera on.
5. Play back the still images / video clips.
 - The method of operation is the same as playing back still images and video clips on the camera.





NOTE

- In the case of the PAL system, images are surrounded by a black frame.
- Refer to section in this manual titled “**Video Output**” in the **Setup Menu (In Playback Mode)** for further details.

Attaching Voice Memos

A maximum of 30 seconds of audio can be recorded like a memo for photographed still images. The voice memo can be recorded only once.

1. Slide the mode switch to [].
 - The last image appears on the screen.
2. Select the image that you want to attach the voice memo with the ▲ / ▼ buttons.
3. Press the shutter button.
 - [VOICE RECORDING] is displayed on the screen and recording starts.
4. To stop recording voice memo during recording, press the shutter button again.
 - [VOICE RECORD END] will be displayed and the recording will end. A [] icon is displayed with images that have been recorded with a voice memo.

Playing back voice memo

A press of the **SET** button displays [VOICE PLAYBACK] and plays back the voice memo.













NOTE

- Voice memo is only available in the still single image capture mode.



Thumbnail Display

This function allows you to view 9 thumbnail images on the LCD monitor at the same time, which can quickly search for the image that you want.

1. Slide the mode switch to [].
 - The last image appears on the screen.
2. Press the **W** button.
 - The images are displayed in the thumbnail display.
 - Images that have been selected with the  /  /  /  buttons will be indicated by a green frame.
 - When there are ten or more images, scroll the screen with the  /  buttons.
3. Press the  /  /  /  buttons to select the image to be displayed at regular size.
4. Press the **SET** button.
 - The selected image is displayed at its regular size.



NOTE

- A [], [], [] icon will be displayed in a thumbnail display.

Zoom Playback

Images that are being play back can be enlarged and displayed in 2 levels of 2 times and 4 times enlargement. This mode also allows you to enlarge your image on the selected portion of the image to check for small details.

- Slide the mode switch to [].
- Press the \blacktriangle / \blacktriangledown buttons to select the image you want to enlarge.
 - You can also select the image you want to enlarge from the thumbnail display.
- Adjust the zoom ratio with the \mathbf{T} / \mathbf{W} buttons.
 - Pressing the \mathbf{T} button enlarges the image.
 - To return to normal magnification, press the \mathbf{W} button.
 - The image is displayed enlarged, and a white frame and green frame are displayed on the LCD monitor.
 - The white frame indicates the entire image, while the green frame shows the location of the currently enlarged area.
- Press the \blacktriangle / \blacktriangledown / \blacktriangleleft / \blacktriangleright buttons to select the area to enlarge.
- To return to regular display, toggle the \mathbf{W} button until the regular display appears on the screen.

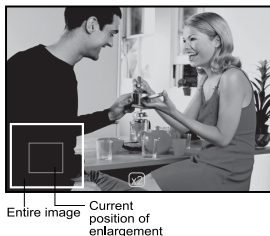

NOTE

- Pressing the \mathbf{T} button magnifies the image from 1x \rightarrow 2x \rightarrow 4x.
- Pressing the \mathbf{W} button reduces the image from 4x \rightarrow 2x \rightarrow 1x.

Slideshow Display

The slideshow function enables you to playback your still images automatically in order one image at a time.

- Slide the mode switch to [].
- Press the **MENU** button.
 - The playback menu is displayed.
- Select [Slide Show] with the **▲** / **▼** buttons, and press the **SET** button.
 - The slideshow starts.
- To stop the slide show during playback, press the **SET** button.
 - The image is displayed on screen when you press the **SET** button.





NOTE

- The Auto OFF function does not operate during slide show.
- All still images in the folder are automatically played back.

Protecting Images

Set the data to read-only to prevent images from being erased by mistake.

Protecting Images

- Slide the mode switch to [].
- Select the image that you want to protect with the ▲ / ▼ buttons.
- Press the **MENU** button.
 - The playback menu is displayed.
- Select [Protect] with the ▲ / ▼ buttons, and press the **SET** button.
- Select [Single] or [All] with the ▲ / ▼ buttons, and press the **SET** button.
- Select [Set] with the ▲ / ▼ buttons, and press the **SET** button.
 - Protect is executed and the camera returns to the play mode.
 - The protect icon [] is displayed with protected images. When [All] has been selected, [] is displayed with all the images.

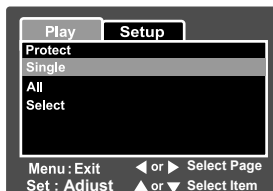

Canceling the Protection

To cancel protection for only one image, display the image that you want to remove the image protection.

1. Select [Protect] with the ▲ / ▼ buttons from the playback menu, and press the **SET** button.
2. Select [Single] or [All] with the ▲ / ▼ buttons, and press the **SET** button.
3. Select [Cancel Protect] with the ▲ / ▼ buttons, and press the **SET** button.
 - The removal of image protection is executed and the camera returns to the play mode.

Protecting multiple images simultaneously

1. Select [Protect] with the ▲ / ▼ buttons from the playback menu, and press the **SET** button.
2. Select [Select] with the ▲ / ▼ buttons, and press the **SET** button.
 - The images are displayed in the thumbnail display.
3. Select the image you want to protect with the ▲ / ▼ / ◀ / ▶ buttons, and press the **IOI** button.
 - The protect icon [] is displayed with protected images. Selecting a protected image and pressing the **IOI** button again will cancel the protection. This procedure is repeated to select multiple images.
4. Press the **SET** button.
 - Protection and cancellation the protection are executed and the camera returns to the play mode.



NOTE

- Formatting the SD card undoes the protection, and erases all images.

DPOF Settings

DPOF is the abbreviation for Digital Print Order Format, which allows you to embed printing information on your memory card. You can select the images to be printed and how many prints to make with the DPOF menu in the camera and insert the memory card to the card compatible printer. When the printer starts printing, it will read the embedded information on the memory card and print the specified images.

- Slide the mode switch to [].
- Select the image that you want to set DPOF with the ▲ / ▼ buttons.
- Press the **MENU** button.
 - The playback menu is displayed.
- Select [DPOF] with the ▲ / ▼ buttons, and press the **SET** button.
 - The DPOF setting screen is displayed.
- Select [Single] or [All] with the ▲ / ▼ buttons, and press the **SET** button.
 - Single: Sets DPOF for each individual image.
 - All: Sets DPOF for all images at once.
- Select [Print Num.] with the ▲ / ▼ buttons, and press the **SET** button.
 - This displays the number of prints setting screen.
- Set the number of prints with the ▲ / ▼ buttons, and press the **SET** button.
 - You can set up to 9 prints for each image.
- Select [Date] with the ▲ / ▼ buttons, and press the **SET** button.
 - The date and time setting screen appears.

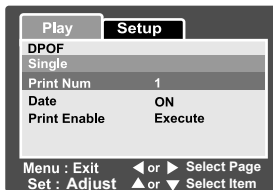
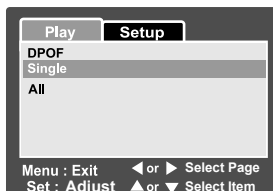

9. Select date to [ON] or [OFF] with the ▲ / ▼ buttons, and press the **SET** button.
 - **ON:** The date of the photograph will also be printed.
 - **OFF:** The date of the photograph will not be printed.
10. Select [Print Enable] with the ▲ / ▼ buttons, and press the **SET** button.
11. Select [Execute] with the ▲ / ▼ buttons, and press the **SET** button.
 - This creates a file containing the DPOF information, and when the operation is finished, the screen returns to the playback screen.
 - To cancel print, simply select [Cancel].



**NOTE**

- The date that is printed on the photo is the date set on the camera. To print the correct date on the photo, set the date on the camera before you photograph the image. Refer to section in this manual titled “**Setting the Date and Time**” for further details.

[] Erasing Images

Erasing at Photography Mode (Quick Delete Function)

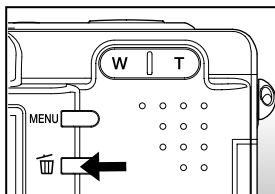

Quick delete function enables you to erase the image during photography. The quick delete menu provides you to directly erase the last image without further settings.

1. Slide the mode switch to [] or [].
2. Press the  button.
 - The last image and quick delete menu appear on the screen.
3. Press the **SET** button to erase the image.
 - To not erase, select [Cancel], and press the **SET** button.



Erasing at Playback Mode

Erasing single image / Erasing all images

1. Slide the mode switch to [].
 - The last image will be displayed on the screen.
2. Select the image you want to erase with the ▲ / ▼ buttons..
3. Press the  button.
 - The deletion menu will be displayed.
4. Select [Single] or [All] with the ▲ / ▼ buttons, and press the **SET** button.
 - Single: Erases the selected image or the last image.
 - All: Erases all of the images on the SD card except for the protected images.
 - Select: Erases a number of selected images.

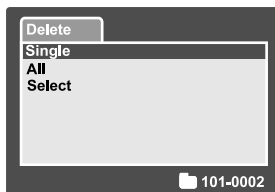





5. Select [Execute] with the ▲ / ▼ buttons, and press the **SET** button.
 - To not erase, select [Cancel], and press the **SET** button.

**NOTE**

- Even if you take photographs after erasing an image, the file number is assigned the next number of the very last one before the image was erased.

Erasing selected images

This erases a number of selected images.

1. Slide the mode switch to [].
2. Press the  button.
 - The deletion menu will be displayed.
3. Select [Select] with the ▲ / ▼ buttons, and press the **SET** button.
 - The images are displayed in the thumbnail display.
4. Select the image you want to erase with the ▲ / ▼ / ◀ / ▶ buttons, and press the  button.
 - The [] icon will be displayed. One more press of the erase button will cancel the operation. Repeat this procedure and select all the images that you want to erase.
5. Press the **SET** button.

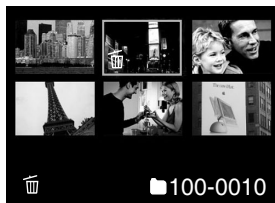
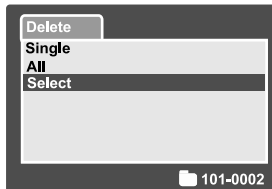

MENU OPTIONS

Still Image Menu (Picture)



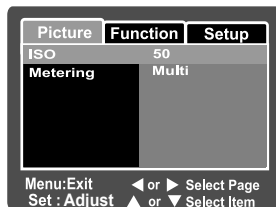
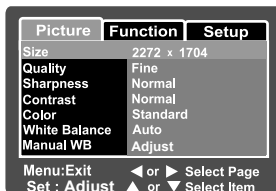
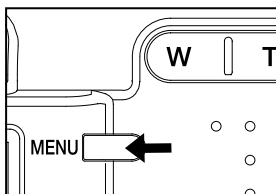

This menu is for the basic settings to be used when taking still images. The setting is not canceled even if the camera is turned off or the Auto OFF function is activated.

1. Slide the mode switch to [].
2. Press the **MENU** button.
 - [Picture] of the still image menu is displayed.
3. Select the desired [Picture] option item with the **▲** / **▼** buttons, and press the **SET** button to enter its respective menu.
4. Select the desired setting with the **▲** / **▼** buttons, and press the **SET** button.
5. To exit from the still image menu, press the **MENU** button.



Size

This sets the size of the image that will be photographed.

- [] **2272 x 1704:** 2272 x 1704 pixels (4M)
- [] **1600 x 1200:** 1600x 1200 pixels (2M)
- [] **1280 x 960:** 1280 x 960 pixels (1M)
- [] **640 x 480:** 640 x 480 pixels (VGA)

Quality

This sets the quality (compression rate) at which the image is taken.

- [★★★] **Fine:** Low compression rate.
- [★★] **Standard:** Normal
- [★] **Economy:** High compression rate

Sharpness

This sets the sharpness of the image that will be photographed.

- Hard:** Hard touch
- Normal:** Normal touch
- Soft:** Soft touch

Contrast

This sets the difference between the bright and dark portions of the image that will be photographed.

- Hard:** Increases the contrast.
- Normal:** Set the contrast automatically.
- Soft:** Decreases the contrast.







Color

This sets the color of the image that will be photographed.

- Standard:** Standard color
- Vivid:** Bright color
- Sepia:** Sepia
- Monochrome:** Black-and-white

White Balance

This sets the white balance photographing under a variety of lighting conditions and permits photographs to be taken that approach the conditions that are seen by the human eye.

- [] **Auto:** Automatic adjustment.
- [] **Incandescent:** Photography under incandescent lighting.
- [] **Fluorescent 1:** Photography under a daylight fluorescent tube with a bluish cast.
- [] **Fluorescent 2:** Photography under a daylight white fluorescent tube with a reddish cast.
- [] **Day Light:** Outdoor photography.
- [] **Cloudy:** Photography under a cloudy sky.
- [] **Manual:** Photography with a Manual WB.

Manual WB

This manually sets the white balance and stores it. Use of this is convenient when the white balance does not offer a good match.

Before select [Execute] determine the subject (such as a white paper) that will be used to set the white balance.

Cancel: Disable manual white balance.

Execute: Enable manual white balance.

ISO

This sets the sensitivity for taking pictures. When the sensitivity is raised (and the ISO figure is increased), photography will become possible even in dark locations, but the more pixilated (grainer) the image will appear.

50: Equivalent to ISO50.

100: High-sensitive photography equivalent to ISO100.

200: High-sensitive photography equivalent to ISO200.

Auto: Automatic setting in the range of ISO 50 to 200.

Metering

This sets the metering method for calculating the exposure.

[] **Multi:** The entire area of the screen is measured, and the exposure is calculated.

[] **Spot:** A very small portion of the center of the screen is measured, and the exposure is calculated.

Still Image Menu (Function)

- Slide the mode switch to [].
- Press the **MENU** button, and select the [Function] menu with the **▶** button.
 - [Function] of the still image menu is displayed.
- Select the desired [Function] option item with the **▲** / **▼** buttons, and press the **SET** button to enter its respective menu.
- Select the desired setting with the **▲** / **▼** buttons, and press the **SET** button.
- To exit from the still image menu, press the **MENU** button.

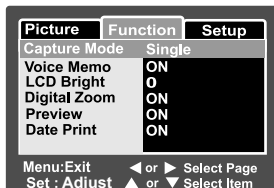

Capture Mode

This sets the recording method at the time of taking pictures.

[Blank] Single: Takes one photograph at a time.

[] Continuous: Permits continuous photography of 3 pictures max, at the fastest interval of 0.5 seconds.

[AEB] Auto Exp.: Effective when it is difficult to determine the exposure for continuous photography with exposure at the 3 levels of standard exposure (0), underexposure (-0.67) and overexposure (+0.67) compensation.



NOTE

- In continuous photography, press and hold the shutter button until 3 images have been captured. If the shutter button is released earlier, the continuous photography will end at that point.

Voice Memo

A voice memo can be recorded for 30 seconds immediately following still single image photography. This feature is also available during playback mode.

Refer to section in this manual titled "**Recording Voice Memos**" for further details.

ON: Enable voice memo.

OFF: Disable voice memo.



NOTE

- When voice memo is set to on, the preview setting is also fixed to on.

LCD Bright.

Select a brightness level for the LCD monitor.

The LCD becomes brighter with the ▲ button and darker with the ▼ button. The adjustment range is from -5 to +5.

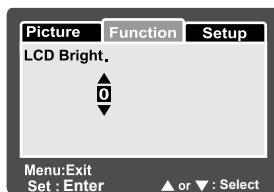

Digital Zoom

This sets whether or not to use digital zoom at the time of photography.

ON: Enable digital zoom.

OFF: Disable digital zoom.

Preview

This sets whether or not to display the photographed image on the screen immediately after the picture is taken.

ON: Displayed when images are being recorded on the SD card.

OFF: Does not display.



NOTE

- A photographed image is displayed on the LCD monitor for 2 seconds. Pressing the shutter button during preview cancels the operation.
- When preview is set to off, the voice memo setting is also fixed to off.

Date Print

The date of recording can be printed directly on the still images. This function must be activated before the image is taken.

ON: Imprints the date on the still images when taking pictures.

OFF: Does not imprint the date on the still images when taking pictures.



Date imprinted here.

Movie Menu (Picture)

This menu is for the basic settings to be used when recording video clips. The setting is not canceled even if the camera is turned off or the Auto OFF function is activated.

1. Slide the mode switch to [].
2. Press the **MENU** button.
 - [Picture] of the movie menu is displayed.
3. Select the desired [Picture] option item with the **▲** / **▼** buttons, and press the **SET** button to enter its respective menu.
4. Select the desired setting with the **▲** / **▼** buttons, and press the **SET** button.
5. To exit from the movie menu, press the **MENU** button.

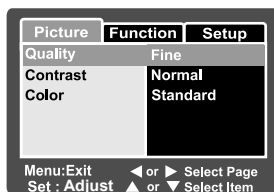

Quality

This sets the quality (compression rate) at which the image is taken.

[★★★] **Fine:** Low compression rate.

[★★] **Standard:** Normal

Contrast

This sets the difference between the bright and dark portions of the image that will be photographed.

Hard: Increases the contrast.

Normal: Set the contrast automatically.

Soft: Decreases the contrast.

Color

This sets the color of the image that will be photographed.

Standard: Standard color

Vivid: Bright color

Sepia: Sepia

Monochrome: Black-and-white

Movie Menu (Function)

- Slide the mode switch to [].
- Press the **MENU** button, and select the [Function] menu with the **▶** button.
 - [Function] of the movie menu is displayed.
- Select the desired [Function] option item with the **▲** / **▼** buttons, and press the **SET** button to enter its respective menu.
- Select the desired setting with the **▲** / **▼** buttons, and press the **SET** button.
- To exit from the movie menu, press the **MENU** button.

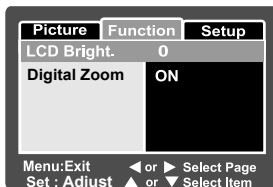

LCD Bright.

Adjust the brightness of the LCD monitor. This function does not adjust the brightness of recorded images.

Refer to section in this manual titled “LCD Bright.” in **Still Image Menu (Function)** for further details.

Digital Zoom

This sets whether or not to use digital zoom at the time of photography.

ON: Enable digital zoom.

OFF: Disable digital zoom.

Playback Menu

In the [] mode, set which settings are to be used for playback. The setting is not canceled even if the camera is turned off or the Auto OFF function is activated.

- Slide the mode switch to [].
- Press the **MENU** button.
 - The playback menu is displayed.
- Select the desired option item with the **▲** / **▼** buttons, and press the **SET** button to enter its respective menu.
- Select the desired setting with the **▲** / **▼** buttons, and press the **SET** button.
- To exit from the playback menu, press the **MENU** button.



Slide Show

Automatically plays back still images in order one image at a time.

Refer to section in this manual titled "**Slideshow Display**" for further details.

DPOF

Set the number of prints and date display in DPOF format to images that you want to print. (This function is available for still images only.) You can print images easily just by inserting the SD card to a DPOF-compatible printer or a print shop.

Refer to section in this manual titled "**DPOF Settings**" for further details.

Protect

Set the data to read-only to prevent images from being erased by mistake.

Refer to section in this manual titled "**Protecting Images**" for further details.



LCD Bright.

Adjust the brightness of the LCD monitor. This function does not adjust the brightness of recorded images.

Refer to section in this manual titled "**LCD Bright.**" in **Still Image Menu (Function)** for further details.

Setup Menu (In Photography Mode)

Set your camera's operating environment. The settings will be saved after the power has been turned off or Auto OFF is activated.

- Slide the mode switch to [] or [].
- Press the **MENU** button, and select the [Setup] menu with the **▶** button.
 - [Setup] of the photography menu is displayed.
- Select the desired [Setup] option item with the **▲** / **▼** buttons, and press the **SET** button to enter its respective menu.
- Select the desired setting with the **▲** / **▼** buttons, and press the **SET** button.
- To exit from the photography menu, press the **MENU** button.

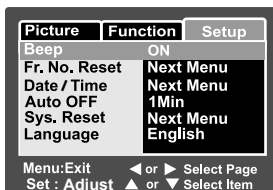

Beep

This sets whether or not to mute the startup sound, and the camera sound each time you press the camera button.

ON: Sounds the beep tone.

OFF: Does not sound the beep tone.

Fr. No. Reset

This creates a new folder. The photographed images are recorded to the newly created folder from number 0001.

Cancel: Does not reset the file number.

Execute: Resets the file number and creates a new folder.

Date/Time

This sets the date and the time.

Refer to section in this manual titled “**Setting the Date and Time**” for further details.

Auto OFF

If no operation is performed for a specific period of time, the power to the camera is automatically turned off. This feature is useful to reduce battery wear.

- 1 Min.:** When the camera has not been operated, it turns the power off after 1 minute.
- 2 Min.:** When the camera has not been operated, it turns the power off after 2 minutes.
- 3 Min.:** When the camera has not been operated, it turns the power off after 3 minutes.



NOTE

- This function does not operate during a slideshow or during PC connection.

Sys. Reset

This returns all basic settings to the camera's default settings. The time setting will not be reset.

Cancel: Does not return to the default settings.

Execute: Returns to the default settings.

Language

This sets the language that is displayed on the LCD monitor.

Refer to section in this manual titled “**Choosing the Language**” for further details.

English: English

Français: French

Deutsch: German

Español: Spanish

Italiano: Italian.

繁體中文: Chinese (Traditional)

简体中文: Chinese (Simplified)

Setup Menu (In Playback Mode)

- Slide the mode switch to [].
- Press the **MENU** button.
 - [Setup] of the playback menu is displayed.
 - If images/video clips are recorded on the SD card, press the **▶** button after the **MENU** button is pressed.
- Select the desired [Setup] option item with the **▲** / **▼** buttons, and press the **SET** button to enter its respective menu.
- Select the desired setting with the **▲** / **▼** buttons, and press the **SET** button.
- To exit from the playback menu, press the **MENU** button.

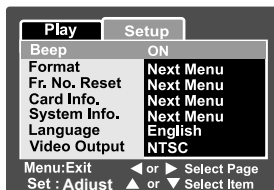
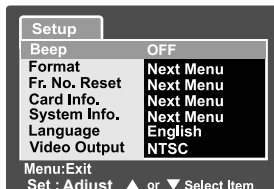

Beep

This sets whether or not to mute the startup sound, and the camera sound each time you press the camera button.

ON: Sounds the beep tone.

OFF: Does not sound the beep tone.

Format

This function erases all images and reformats the SD card loaded in your camera. Protected images are also erased. SD card cannot be formatted if it is write-protected.

Refer to section in this manual titled “**Formatting the SD Card**” for further details.

Fr. No. Reset

This creates a new folder. The photographed images are recorded to the newly created folder from number 0001.

Cancel: Does not reset the file number.

Execute: Resets the file number and creates a new folder.

Card Info.

This allows a check of the free capacity of the SD card as well as other information.

System Info.

This displays the firmware version of the camera.

Language

This sets the language that is displayed on the LCD monitor.

Refer to section in this manual titled “**Choosing the Language**” for further details.

English: English

Français: French

Deutsch: German

Español: Spanish

Italiano: Italian.

繁體中文: Chinese (Traditional)

简体中文: Chinese (Simplified)

Video Output

This sets video output system of the video equipment that you are going to connect to the camera.

NTSC: NTSC system.

PAL: PAL system.

TRANSFERRING RECORDED IMAGES AND VIDEOS TO YOUR COMPUTER

To transfer images/video clips from the camera to your computer, follow these steps:

Step 1: Installing the USB driver (Windows 98 users only)

Step 2: Connecting the camera to your computer

Step 3: Downloading images and video files

System Requirements

For the camera to be connected directly to the computer and used as a mass-storage device, the computer must be equipped with a USB port as a standard interface. The computer and the operating system must be guaranteed by their manufacturers to support USB interface. The following operating systems are compatible with the camera:

Windows 98, 98SE, Me, 2000 Professional, and XP Home and Professional editions.

Mac OS 9.0.-9.2.2 and Mac OS X 10.1.3.-10.1.5, 10.2.1.-10.2.8, 10.3.-10.3.5.

Step 1: Installing the USB Driver

Windows 98 computers

The USB driver on the CD-ROM is exclusively for Windows 98 computers. Installing the USB driver on computers running Windows 2000/ME/XP is not necessary.

1. Insert the CD-ROM that came with the camera into your CD-ROM drive. The welcome screen appears.
2. Click **"INSTALL USB DRIVER"**. Follow the on-screen instructions to complete the installation. After the USB driver has been installed, restart your computer.



Step 2: Connecting the Camera to Your Computer

1. Connect one end of the USB cable to the conversion adapter terminal of the camera.
 - If you use the conversion adapter to connect the USB cable, insert the conversion adapter into the conversion adapter terminal of the camera first, and then connect one end of the USB cable to the USB terminal of the conversion adapter.
2. Connect the other end of the USB cable to an available USB port on your computer.

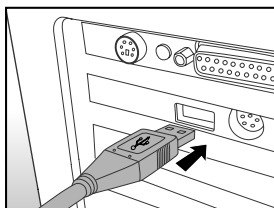
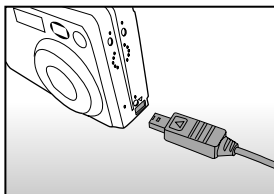

3. From the Windows desktop, double click on "My Computer".
4. Look for a new "Removable disk" icon. This "Removable disk" is actually the memory card in your camera. Typically, the camera will be assigned drive letter "e" or higher.
5. Double click on the removable disk and locate the DCIM folder.
6. Double click on the DCIM folder to open it to find more folders.
 - Your recorded images and video clips will be inside these folders.
 - Copy & Paste or Drag-N-Drop image and video files to a folder on your computer.

Mac users: Double-click the "untitled" or "NO_NAME" disk drive icon on our desktop. iPhoto may automatically launch. The volume name varies between memory cards.



NOTE

- The data saved to the SD card may be damaged if the power to the camera is cut off during image transfer. We recommend that you use the AC power adapter when connecting the camera to the PC.

Step 3: Downloading Images and Video Files

When the camera is turned on and connected to your computer, it is considered to be a disk drive, just like a floppy disk or CD. You can download (transfer) images by copying them from the “Removable disk” to your computer hard drive.

Windows

Open the “removable disk” and subsequent folders by double clicking on them. Your images are inside these folder(s). Select the images that you want, and then choose “Copy” from the “Edit” menu. Open the destination location (folder) and choose “Paste” from the “Edit” menu. You may also drag and drop image files from the camera to a desired location.

Macintosh

Open the “untitled” disk icon, and the destination location on your hard disk. Drag and drop from the camera to the desired destination.



NOTE

- Do not open the battery cover during USB cable connection.
- Memory card users may prefer to use a memory card reader (highly recommended).
- Video playback application is not included with the package. Make sure that video playback application has been installed in your computer.

INSTALLING PHOTOSUITE

PC users will find that PhotoSuite is a very user-friendly image-editing program. With PhotoSuite, you can retouch, compose, and organize your images. It includes a variety of templates, such as photo frames, birthday cards, calendars and more. Get your images ready and explore this amazing program.

To install PhotoSuite:

1. Insert the CD-ROM that came with the camera into your CD-ROM drive. The welcome screen appears.
2. Click **"INSTALL PHOTO SUITE"**. Follow the onscreen instructions to complete the installation.



NOTE

- To use PhotoSuite to edit and retouch your recorded images, please refer to the on-line help.
- For Windows 2000/XP users, please make sure to install and use the PhotoSuite in "Administrator" mode.
- PhotoSuite is not supported on the Mac. iPhoto or iPhoto2 is recommended.

INSTALLING PHOTOVISTA

PC users will find that PhotoVista is an easy-to-use program that lets you create spectacular 360 degree panoramic images in a snap. When you view these panoramas, you get the experience of being totally immersed in a realistic environment. PhotoVista's powerful engine quickly and automatically stitches images together, and its intuitive interface will let even a novice get great results in minutes.

To install PhotoVista:

1. Insert the CD-ROM that came with the camera into your CD-ROM drive. The welcome screen appears.
2. Click **"INSTALL PHOTO VISTA"**. Follow the onscreen instructions to complete the installation.



NOTE

- To use PhotoVista to create spectacular 360 degree panoramic images, please refer to the on-line help for this software.
- For Windows 2000/XP users, please make sure to install and use the PhotoVista in Administrator" mode.
- PhotoVista is not supported on the Mac.
- Windows XP users who have not installed XP Service Pack 1, be sure to link to http://www.java.com/en/download/windows_automatic.jsp first and download the Java Virtual Machine installation. For more information about Java, please refer to its on-line help at <http://java.sun.com/getjava/help.html>! After this Java installation, you can install iSee Media PhotoVista.
- PhotoVista System Requirements are:
 - * Windows 98, Windows NT 4 (Service Pack 3 or higher)
 - * Windows 2000, Windows Me, Windows XP (Service Pack 1 or higher)

CONNECTING THE CAMERA TO OTHER DEVICES

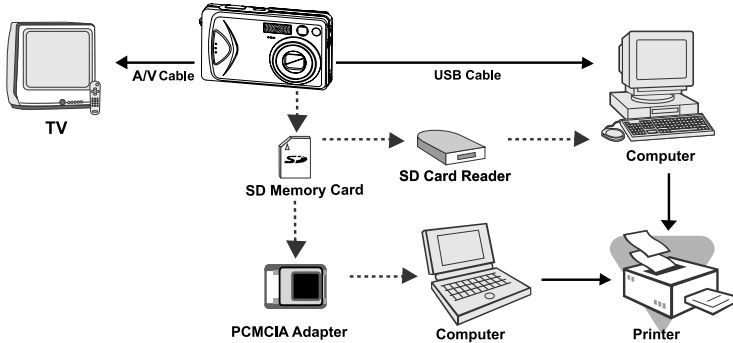

CAMERA SPECIFICATIONS

| Item | Description |
|-----------------------|---|
| Image sensor | 1/2.5" CCD sensor Total number of pixels: approx. 4.2 mega pixels Number of effective pixels: approx. 4.0 mega pixels |
| Image resolution | <Still image> 2272 x 1704, 1600 x 1200, 1280 x 960, 640 x 480 < Video clip> 320 x 240 |
| LCD monitor | 2.0" LTPS TFT color LCD |
| Viewfinder | Real image optical zoom viewfinder |
| Image quality | Fine / Standard / Economy |
| Recording media | External memory: Supports SD card (up to 512MB) |
| Compression format | JPEG compliant |
| Image file format | DCF 1.0, DPOF 1.1, EXIF 2.2, AVI |
| Lens | 3x optical zoom lens F=2.8 - 4.8 f=5.4 mm - 16.2 mm (equivalent to 32 mm - 96 mm on a 35 mm camera) |
| Focus range | Approx. 50 cm to infinity (both Wide and Tele) Approx. 6 cm to infinity (Macro Wide) Approx. 35 cm to infinity (Macro Tele) |
| Auto-Focus | TTL method AF |
| Shutter speed | 1/2 - 1/1000 sec. |
| Image capturing | Single / 3 images with -0.67, 0, +0.67EV / 3 images continuously |
| Digital zoom | 3.6x (Photography mode) 2x and 4x (Playback mode) |
| Metering system | Multi / Spot |
| Exposure compensation | -2EV - +2EV (in 0.3EV increments) |

| | |
|-----------------------|---|
| White balance | Auto / Incandescent / Fluorescent 1/ Fluorescent 2 / Daylight / Cloudy / Manual |
| Flash | Auto Flash / Red-eye Reduction / Night Scene / Suppressed Flash / Forced Flash |
| Flash effective range | 0.5 m -2.7 m |
| ISO sensitivity | Equivalent to ISO 50/100/200/Auto (ISO 50-ISO 200) |
| Self-timer | 10 sec. / 2 sec. / 10+2 sec. |
| Video output | NTSC/PAL |
| Interface | DC IN 5V terminal (Via conversion adapter) A/V OUT terminal (Via conversion adapter) USB 2.0 (Full speed) |
| Power supply | Rechargeable Lithium-ion battery (3.7V) Battery Charger/AC Adapter (5V) |
| Dimension (WxDxH) | Approx. 88.5 x 24 x 54.5mm (without protruding parts) |
| Weight | Approx. 125 g (without the battery & SD card) |

*Design and specifications are subject to change without notice.