

# Konica

Digital Still Camera

## Digital Revio

### KD-310Z

---

## User's Guide

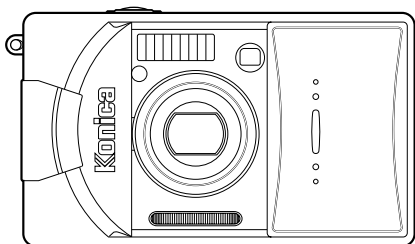

Thank you for your purchase. For the correct usage of this product, please read this User's Manual and warranty card carefully and keep them in a safe place for future reference.

Before accepting the warranty card, please make sure that the date of purchase and the dealer's details have been completed.

# Getting Started

**Please be sure to read this manual before use.**

- **Test shooting**

Be sure to take some test shots before taking important pictures (such as business or weddings) to make sure that the camera is working properly.

- **Results are not guaranteed**

In the unlikely event that a problem arises in shooting or reproducing pictures due to the camera or memory card used, please understand that no compensation can be made.

- **Be aware of Copyright**

Any pictures that you take of existing images may be used for personal use only. Copyright law prohibits the use of pictures without the permission of the rightful owner. Also, please note that some occasions of the performing arts, demonstrations and exhibitions may restrict photography even for the purpose of personal enjoyment.

## **Caution for Extended Camera Use:**

The camera body may become hot when used for a long period of time, but it doesn't mean that the camera is broken. However, if the camera keeps touching the skin for a long time, this may cause a cryogenic burn. Please be careful with it.

## **About trademarks**

- Windows 98, Windows 98SE, Windows XP, Windows 2000 Professional and Windows Me are trademarks or registered trademarks of Microsoft Corporation in the U.S. and other countries.
- Apple, Macintosh, Mac OS, QuickTime and Power PC are trademarks or registered trademarks of Apple Computer in the U.S. and other countries.
- Other company names and product names are trademarks or registered trademarks of their respective owners.







\* The illustrations in this guide are for the purpose of explanation and may differ from the actual design of your camera.

<b>Important Safety Precautions .....</b>	<b>6</b>
---	----------

## **Preparation**

<b>Necessary Accessories .....</b>	<b>11</b>
<b>Names of Parts .....</b>	<b>14</b>
Camera Body .....	14
Operation Buttons .....	16
<b>Attaching the Strap .....</b>	<b>17</b>
<b>Preparing the Power Supply .....</b>	<b>18</b>
Charging the (supplied) Battery Pack .....	18
Installing the (supplied) Battery Pack .....	19
Connecting the AC Adapter (sold separately) .....	22
<b>Turning the Power ON/OFF .....</b>	<b>23</b>
<b>Setting the Menu Language/Date and Time .....</b>	<b>24</b>
<b>Inserting/Removing Cards .....</b>	<b>26</b>

## **Basic Operation**

<b>Taking Pictures .....</b>	<b>29</b>
Holding Your Camera .....	29
Viewfinder and Indicator LEDs .....	29
Taking Pictures using the Viewfinder .....	31
Shooting with Focus Lock .....	34
Taking Pictures using the LCD Monitor .....	35
<b>Selecting the Shooting Mode .....</b>	<b>38</b>
AUTO (Auto Flash) .....	39
 Red-Eye Reduction .....	39
 Fill-In .....	40
 Slow-Sync .....	40
 Off (Flash Override) .....	40
 Macro-photo Mode .....	41
 Distant View Mode .....	41
 Self-Timer Mode .....	41

## **Advanced Shooting**

<b>Using the REC Menu .....</b>	<b>42</b>
Setting with the REC (BASIC) Menu .....	42

# Contents (Cont'd)

Selecting the Image Size .....	43
Shooting Movies .....	45
Adjusting the Brightness of the LCD Monitor .....	47
Selecting the Set-up Menu .....	48
Setting with the REC (DETAILS) Menu .....	49
Returning to Default Settings .....	50
Selecting a Combination of Image Sizes and Compression Ratios .....	51
Adjusting Exposure Compensation .....	53
Adjusting White Balance .....	54
Using the Digital Zoom .....	55
Changing Auto-Exposure (AE) Modes .....	56
Changing to the Slow Shutter Speed Mode .....	57
Taking Sepia Tone Photos .....	58

## **Basic Playback/Erasing**

<b>Playback .....</b>	<b>59</b>
Playing Back Pre-recorded Images .....	59
Playing Back Movies .....	61
Playing Back Enlarged Images (Digital Zoom) .....	62
Using the Quick-view Function .....	63
<b>Erasing the Playback Image .....</b>	<b>64</b>

## **Advanced Playback/Erasing**

<b>Using the PLAY Menu .....</b>	<b>65</b>
Viewing Multiple Pages at Once (Index Playback) .....	66
Copying an Image .....	67
Erasing Unwanted Images .....	70
Adjusting LCD Monitor Brightness .....	73
Selecting/Deselecting Images to Print (DPOF) .....	74
Reducing Image Size (Resizing) .....	78
Setting/Canceling Protection for Your Important Images ...	79
Moving the Image Data to Another Memory Card .....	82
Playing a Slide Show .....	85

# Contents (Cont'd)

Selecting the Set-up Menu .....	85
---------------------------------	----

## **Advanced Operations**

<b>Using the Set-up Menu .....</b>	<b>86</b>
Formatting a Memory Card .....	87
REC Menu Settings .....	88
Quick View Settings .....	88
Make so the Image Information is not displayed .....	89
Setting the Operation Sounds .....	89
Adjusting the Date and Time .....	90
Setting the Self-timer Delay Time .....	90
Setting the Auto Power-OFF Time .....	91
Resetting the File Numbers .....	91
Setting Memory Priority .....	92
Changing Languages .....	92
Restoring the Default Settings .....	93

## **Others**

<b>Connecting to your PC .....</b>	<b>94</b>
Operating Environments .....	94
Connecting with a USB cable .....	95
Downloading (transferring) Images .....	96
<b>Installing software from the CD-ROM supplied .....</b>	<b>98</b>
Installing USB Driver Software .....	98
Using Windows .....	100
Using Macintosh .....	102
<b>When Carrying the Camera Overseas .....</b>	<b>103</b>
<b>Care and Storage .....</b>	<b>104</b>
<b>Troubleshooting .....</b>	<b>106</b>
<b>Main Specifications .....</b>	<b>108</b>
<b>Warranty and After-sales Service .....</b>	<b>110</b>

# Important Safety Precautions

This product has been designed with safety in mind; however, please read the following display marks, warnings and cautions for its correct usage.

The following warning and caution symbols are to prevent damage to the user, other persons and property.

## Definitions of the symbols

**The following categories explain the degree of danger or damage that may occur if the displayed content is not followed or the product is misused.**



### **Warning**

This symbol indicates that misuse may result in serious injury and even death.

---



### **Caution**

This symbol indicates that misuse may result in bodily injury or physical damage.

**The following categories explain the contents to be followed using symbols.**



This symbol indicates that the content requires caution when performed.



This symbol indicates that the content is prohibited.



This symbol indicates that the content must always be followed.

# Important Safety Precautions (Cont'd)

## **Warning**



Should any of the following occur, stop using the product immediately. Remove the batteries from the unit and disconnect the AC adapter. If using the AC adapter, disconnect the power plug from the wall outlet.

Consult the dealer from whom you bought the product for further assistance.

Continued use of the product may result in fire or electrical shock.

- **If you notice any abnormality such as smoke or an abnormal smell, or if the camera becomes extremely hot.**
- **If liquid gets inside the camera.**
- **If any foreign object gets inside the camera.**



**Do not dismantle, modify or repair the camera yourself.**

Fire and/or electrical shock may occur as a result.

For repair or internal inspection, consult the dealer from whom you bought the product.



**Do not allow the camera to get wet.**

Fire, electrical shock and/or malfunction of the unit may occur if internal parts are exposed to water or other liquids.



**Do not drop or insert metal objects or combustible items inside the camera.**

Fire, electrical shock and/or malfunction of the unit may occur as a result of metal objects, etc. getting inside the camera.



**Do not use the camera while driving.**

May cause traffic accidents.

When using the camera while walking, pay attention to the road surface, surroundings, etc.



**Do not use the camera on unstable ground.**

Serious injury and even death may occur as a result especially when falling from high places.

# Important Safety Precautions (Cont'd)

## **Warning**



**Do not directly look at the sun through the viewfinder.**  
Loss of or impaired eyesight may result.



**Do not touch the metal parts on the camera during thunder and lightning.**  
Death may occur if lightning strikes the camera.



**Do not use AC adapters other than those specified.**  
Fire may occur as a result of AC adapters other than those specified being used.



**Do not dismantle, short-circuit, coat (solder, etc.), apply heat, apply pressure (with nail, etc.) to the battery, or throw into a fire. Furthermore, do not allow metals (wires, necklaces, etc.) to come into contact with batteries.**  
Fluid leakage, heat, fire and damage may occur as a result.

## **Caution**



**Do not point the lens directly at the sun or at a strong light source.**  
Malfunction of internal parts may occur from concentrated rays of light. Using the camera in such conditions may cause short circuits and breakdown of insulation, resulting in overheating and/or fire.



**Take care not to get fingers caught in the battery/card cover.**  
Personal injury may occur as a result.



**When using the camera inside an airplane, follow the directions of the airline company.**  
Electric waves emitted from the camera may affect airplane cockpit instruments.



**Do not use the flash near eyes.**  
Eye injury may occur as a result.



## Important Safety Precautions (Cont'd)

### **Caution**



**When taking a picture, wipe off the flash surface and be careful not to cover the flash.**

If the flash surface is dirty or you take a shot with the flash covered, it is possible for the flash surface quality or color to change, due to the high temperature of the flash.



**Check that the polarity is correct when inserting batteries.**

The battery may heat, damage or leak if the polarity is not correct, possibly causing skin burns and/or personal injury as a result.



**Do not use batteries which have become soiled with oil or sweat.**

If soiled, wipe the contacts with a dry cloth before use.



**When cleaning or carrying out non-photographic operations on the camera, disconnect the AC adapter for safety.**



**Do not leave the camera in locations such as:**

- **A location exposed to direct sunlight or inside a car, etc. where the temperature may become extremely high.**

Fire and/or damage to the unit may occur.

- **Within the reach of children.**

The strap may wrap around the neck causing strangulation, or accessories such as batteries, Memory Card, etc. may be swallowed.

- **Unstable surfaces such as on an unstable table or an angled surface.**

Camera dropping on the head or other body parts may not only cause personal injury but malfunction of the unit as well.

- **A location exposed to lampblack, steam, high humidity, dust or vibration.**

If dust or liquid enters the camera or if the internal parts are damaged by strong vibration, overheating, fire or electrical shock may occur as a result.

## Important Safety Precautions (Cont'd)

### **Caution**



**Remove the batteries when the camera will not be used for an extended period.**



**Do not use force when operating the camera.**

The camera may become damaged, causing personal injury as a result.



**Do not rotate the camera when mounting on a tripod.**

#### **About battery fluid leakage**

- Should battery fluid leaks ever come into contact with hands or clothing, wash immediately with water.
- Loss of eyesight may occur if battery fluid enters the eye. In such case, do not rub the eye. Immediately flush the eye with water and seek medical attention.

#### **About the LCD monitor**

- Due to the characteristics of liquid crystals, the brightness of the LCD monitor may appear uneven with changes in temperature, etc.
- The LCD monitor has been developed using high-precision engineering and is superior in sharpness and picture quality. Due to the nature of liquid crystals, however, there may be missing or constantly lit pixels on the monitor. This is not a malfunction of the unit.
- If the LCD monitor becomes damaged for some reason, take care to prevent personal injury from broken glass, etc. Furthermore, take care that liquid crystals do not touch the skin or enter the eyes or mouth.

## Checking the Packing Contents

The following accessories should be packed with your new camera; please make sure all are enclosed after opening the packaging. In the unlikely event that something is missing, please contact the sales outlet.

1) Lithium-ion battery (Model No. DR-LB4)	× 1
2) Battery Charger (Model No. DR-BC-K4), Power Supply cord	× 1
3) USB cable	× 1
4) CD-ROM	× 1
5) Strap	× 1
6) Quick Guide	× 1
7) Warranty card	× 1
8) SD Memory Card	× 1

\* If you purchase this product in Japan, the packing contents will be different from what mentioned above.

## This product can be used with the following power supplies:

### 1) Lithium-ion battery (the packaged item or purchased separately)

- Read the user's guide on the battery and the charger thoroughly, and use them accordingly.
- You cannot charge the battery in the camera.
- When disposing of rechargeable batteries, please support recycling by participating in the recovering system of the store from which you bought the batteries.
- The number of pictures you can take varies with the conditions of use and the performance of the rechargeable batteries

\* Please refer to page 20 for information on battery life.

### 2) Plugging in at home

- Connect the designated AC adapter (sold separately, model number: DR-AC4).

## Items Sold Separately

- AC adapter kit (Model No.: DR-AC4)
- Lithium-ion Battery (Model No.: DR-LB4)
- Soft Camera Case (Model No.: DR-CC4)

## Necessary Accessories (Cont'd)

### Compatible Recording Media

This camera comes with approximately 2 MB of memory installed, but if you would like to use additional memory, the following cards are compatible:

- SD Memory Card
- MultiMedia Card
- Memory Stick

### About the SD Memory Card/Multi-Media Card/Memory Stick

#### **Caution**

**SD Memory Cards, Multi-Media Cards and Memory Stick are manufactured using precision electronic components. Do not perform the following as malfunction or damage may occur as a result.**

- Do not touch the terminals with hands or metal objects. Damage to the components may occur as a result of static electricity. Before handling an SD Memory Card, Multi-Media Card or Memory Stick, discharge any static build-up from your body by touching grounded metal, etc.
- Do not bend, drop or apply excessive force.
- Avoid heat, liquid and direct sunlight when using and for storage.
- Do not open the battery/card cover or remove the SD Memory Card/Multi-Media Card/Memory Stick while data is being read or written.
- Do not dismantle or modify.



\* The SD logo is a trademark.

\* "Memory Stick" and  are trademarks of Sony Corporation.

## Necessary Accessories (Cont'd)

### Important

- **In the event of malfunction or damage, it is possible that data may be lost. Konica can not accept responsibility in any way for such data loss.**
- Always back-up important data.
- When using SD Memory Cards/Multi-Media Cards/Memory Stick on a PC, do not change the attributes(read-only, etc.) of the files (image data) on the card. Doing so may prevent the camera from working properly when deleting images, etc.
- Do not change the file names or the directory name of image data saved on an SD Memory Card/Multi-Media Card/Memory Stick using a PC or save files other than image data taken by this camera. Images that have been changed or added will not only play back on the camera but may cause the camera to malfunction as well.
- Always format SD Memory Cards/Multi-Media Cards/Memory Stick using this camera. A card formatted in a PC may not operate properly.
- The SD Memory Card and Memory Stick includes a write-protect switch.  
Sliding this switch downward prevents data from being written to the card and images, etc. saved on the card are protected.  
Please note that pictures cannot be taken or deleted when the write-protect switch is on.
- When using a large-capacity card, card check and deletion may take some time.
- When using Multi-Media Cards, the operation response time may be longer during shooting and playback when compared with SD Memory Cards. However, this is due to the specification of the Multi-Media Card and is not a malfunction.

# Names of Parts

## Camera Body

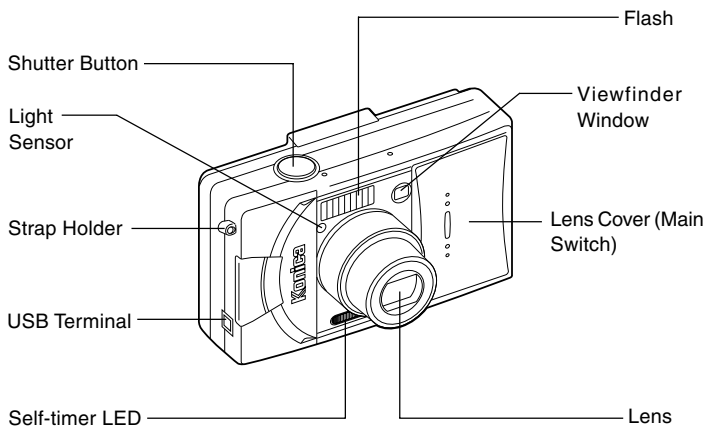

## Names of Parts (Cont'd)

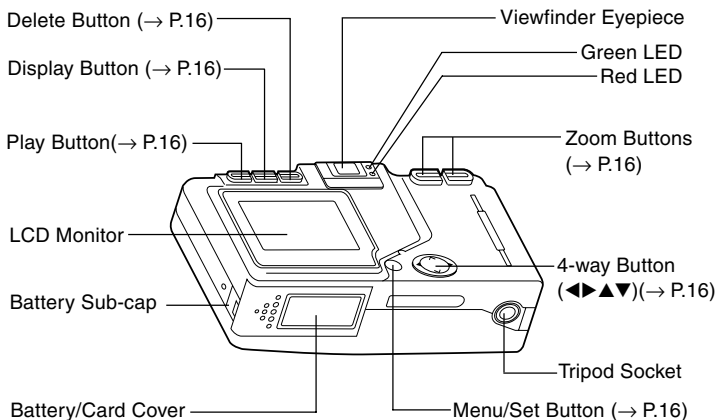

## Operation Buttons

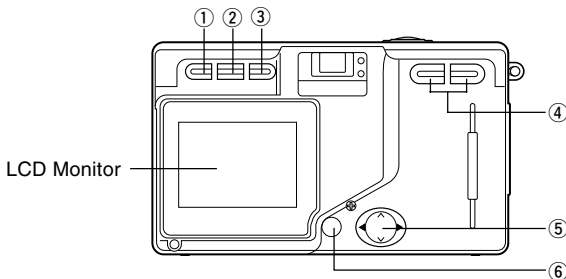

① **Play Button (▶)**

Use this button for playing back images, or setting up the play menu. This button can be used whether the camera's power is ON or OFF (p.23).

② **Display Button**

For turning LCD monitor on and off, and switching the picture information display on and off. When the power is ON, the LCD monitor lights, so it should be turned OFF when you are shooting through the viewfinder.

③ **Delete Button (🗑)**

For deleting unwanted photos.

④ **Zoom Buttons**

For operating the optical and digital zoom functions.

⑤ **4-way Button (◀▶▲▼)**

Use the different buttons ◀, ▶, ▲, and ▼, to select menu items, images, etc. This button is used for the following:

- Selecting shooting mode
- Selecting menus
- Selecting pictures
- Scrolling a picture in an enlarged display

⑥ **Menu/Set Button**

For displaying the menu screen, selecting the contents and confirming choices.



# Attaching the Strap

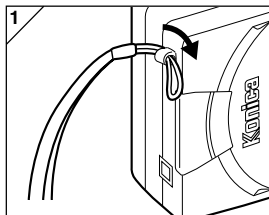

1. Push the loop on the small end of the strap through the strap holder.

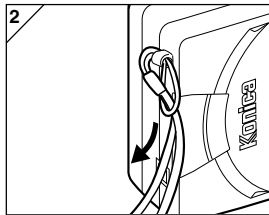

2. Pass the other end of the strap through the loop that is sticking out from the strap holder.



**Warning:** When using the camera with the strap attached, take care so that it does not wrap around the neck. On no account hang the camera round the neck of small children and infants. Strangulation may occur as a result if the strap wraps around the neck.



- When carrying the camera hanging from the strap, take care so that it is not accidentally hit nearby objects.
- Place the camera on a stable surface before installing the strap, to avoid the possibility of it being dropped and damaged.

# Preparing the Power Supply

## Charging the (supplied) Battery Pack

- Charge the battery pack before you use it for the first time and when the LCD monitor indicates, "NO MORE POWER".

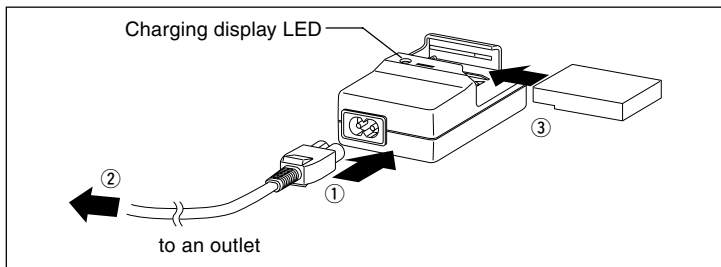

1. Connect the power cord to the charger.
2. Plug the cord into an outlet.
3. Put the battery pack in the charger.
  - While the battery pack is being charged, the charging display LED will be red; when the battery pack is fully charged, the light will turn green.
4. After charging, remove the battery pack from the charger and then the power cord from the outlet and the charger.
  - Normal charging time is about 2.5 hours. Please charge your battery pack in an area with a temperature between 0°C (32°F) and 40°C (104°F).
  - Charging time will vary with the surrounding temperature and the condition of the battery pack.
  - Before using new battery packs or battery packs that have not been used for some time, be absolutely sure to charge them.
  - When a battery pack reaches the end of its useful life, it can be used only for a short time, even when fully charged. When that happens, replace with a new battery pack (sold separately, model # DR-LB4).
  - During charging both the charger and the battery pack get hot; this is normal.
  - If dirt gets on the battery contact points, the battery pack will not be fully charged or charging time will get longer. Please wipe them off with a soft, dry cloth.

# Preparing the Power Supply (Cont'd)

## Installing the (supplied) Battery Pack

- Before installing or changing battery packs, make sure the power is OFF (p.23), check that the LCD monitor is not lit and turn off all switches.

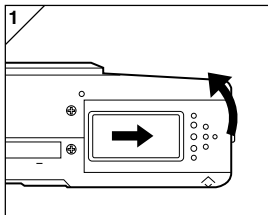

1. Open the battery/card cover by sliding it in the direction of the arrow.



**Do not change the battery with wet hands, as there is a danger of electric shock.**

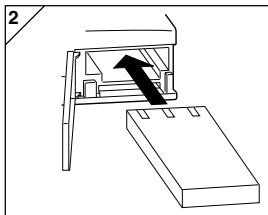

2. Install the battery with the terminals facing inside the camera. After making sure the battery pack is properly installed, close the battery/card cover securely.

**Make sure that the battery pack is facing the right way. If the battery pack is installed incorrectly, there is a danger of injury or contamination, or the camera may be damaged due to leakage and/or heat.**

## Battery level indicator

As the battery runs out of power, the battery level indicator displays the power remaining as follows:

(Remaining power is shown on the LCD monitor in two levels)



1. Fully charged



2. Power is running out; change (charge) the battery.

# Preparing the Power Supply (Cont'd)

## Battery life guide (reference)

Number of Pictures		Continuous Playback Time
With LCD Monitor On	With LCD Monitor Off	
About 100	About 200	About 90 Minutes

- \* Our test conditions: Normal humidity and temperature, flash intensity 50%, shot every 30 sec. Zoomed one direction, once, 2048 × 1536 pixels.
- \* The Battery life will vary depending on the environment, shooting mode, and shooting conditions.
- \* The above values are for reference only and are not guaranteed.
- \* Power is consumed by the following operations even when not recording and these will reduce the number of images that can be recorded.
  - Repeated focus operations by pressing the shutter button halfway.
  - Repeated zoom operations.
  - Extensive use of the LCD monitor in the Playback mode.
  - Communication with a PC.



### Warning

- **When you continue using the camera for a long time, the batteries become hot. Contact with the batteries can lead to burns.**
- **Never open the battery/card cover while the camera is accessing the card or processing images (p.32).**
- **To recharge the battery (DR-LB4), do not use any charger other than the supplied charger (DR-BC-K4). Also, do not use the supplied charger (DR-BC-K4) to recharge batteries other than our special battery (DR-LB4)**
- **Do not leave the battery anywhere where the temperature may reach 60°C<sup>o</sup> (140°F), such as inside a car, in the sun, near a heater, etc.**
- **Do not get the battery wet, drop it or subject it to violent shocks.**

### • Charger (DR-BC-K4)

#### Main Specifications

- Input voltage : AC100-240V (50/60Hz)
- Rated Input : 8VA (100V) 12 VA (240V)
- Rated Output : DC4.2V/600mA
- Recharge time : Approx. 2.5hr
- Temperature for use: 0°-40°C (32°-104°F)
- Storage temperature: -20°-60°C (-4°-76°F)
- External dimensions:
  - 55(W) × 30(H) × 90(D) mm
  - 2<sup>1</sup>/<sub>4</sub>"(W) × 1<sup>1</sup>/<sub>4</sub>"(H) × 3<sup>5</sup>/<sub>8</sub>"(D)
- Weight : Approx. 70g (2oz)

### • Lithium-ion Battery (DR-LB4)

#### Main Specifications

- Nominal voltage : 3.7 V
- Nominal capacity: 820mAh
- Temperature for use: 0°-40°C (32°-104°F)
- External dimensions :
  - 31.8(W) × 9(H) × 49.8(D) mm
  - 1<sup>5</sup>/<sub>16</sub>"(W) × 3/<sub>8</sub>"(H) × 2"(D)
- Weight : Approx. 25g (1oz)

## Preparing the Power Supply (Cont'd)

Please co-operate in recycling the lithium battery.

- This product uses a lithium battery.
- This battery is recyclable and a valuable resource.
- For recycling exhausted batteries or batteries removed from a used product, as a precaution against a short circuit, that could result in smoke or fire, please tape the terminals to insulate them or put them in a plastic bag and take them to a retailer participating in a recycling program, where you can deposit them in a recycling box for rechargeable batteries.

Warnings about recycling

- ⊗ Do not short circuit the battery. This may cause a fire or electrical shock.
- ⊗ Do not peel off the outer cover (insulation cover, tube, etc.) This may cause the battery to leak, get hot, catch fire, or explode.
- ⊗ Do not dismantle the battery. This may cause it to leak, get hot, catch fire, or explode.

### FCC Compliance Statement:

This device complies with Part 15 of the FCC Rules. Operation is subject to the following two conditions:

- (1) this device may not cause harmful interference and (2) this device must accept any interference received, including interference that may cause undesired operation.

This equipment has been tested and found to comply with the limits for a class B digital device, pursuant to Part 15 of the FCC Rules. These limits are designed to provide reasonable protection against harmful interference in a residential installation. This equipment generates, uses and can radiate radio frequency energy and, if not installed and used in accordance with the instructions, may cause harmful interference to radio communications. However, there is no guarantee that interference will not occur in a particular installation. If this equipment does cause harmful interference to radio or television reception, which can be determined by turning the equipment off and on, the user is encouraged to try to correct the interference by one or more of the following measures:

- Reorient or relocate the receiving antenna.
- Increase the separation between the equipment and receiver.
- Connect the equipment into an outlet on a circuit different from that to which the receiver is connected.
- Consult the dealer or an experienced radio/TV technician for help.
- The user is cautioned that changes and modifications made to the equipment without approval of the manufacturer could void the user's authority to operate this equipment.

### Industry Canada's Compliance Statement:

This Class B digital apparatus complies with Canadian ICES-003.

Cet appareil numérique de la classe B est conforme à la norme NMB-003 du Canada.

# Preparing the Power Supply (Cont'd)

## Connecting the AC Adapter (sold separately)

- If you do not want to worry about battery consumption, we recommend using the specified AC adapter (sold separately, model#DR-AC4) when shooting pictures, during playback, or when transferring data (USB connection).
- Only use the AC adapter (sold separately) specified for your camera as use of any other device may result in a breakdown, fire or electrical shock.
- Make sure the camera is OFF, check that the LCD monitor is not lit and turn OFF all power.
- After reading the "Important Safety Precautions" (pp.7-10) in this manual and the warnings supplied with the AC adapter, connect the adapter as instructed.

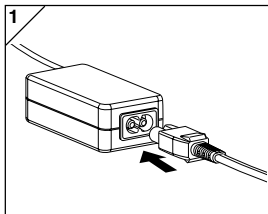

1. Connect the AC adapter to the power supply cord, and plug in the power supply plug.

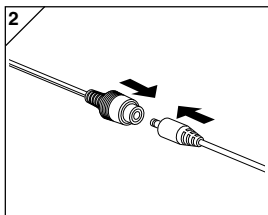

2. Insert the connecting plug of the battery type adapter to the AC adapter plug.

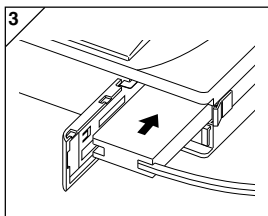

3. After opening the battery/card cover, remove the battery sub-cap. Insert the battery adapter in the battery compartment, and close the battery/card cover.
  - When finished using the camera, turn OFF the power supply to the camera, and then disconnect the connecting plug of the battery-type plug from the AC adapter.

# Turning the Power ON/OFF

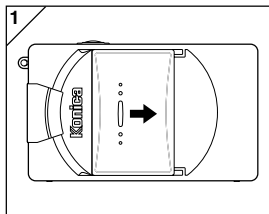

1. Gently slide the lens cover (main switch) in the direction indicated by the arrow until it stops.

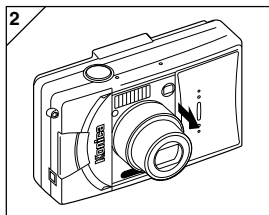

2. Once the lens extends to the shooting position (wide-angle side), the power will come on.
  - With the power on it is possible to shoot pictures. Also, the LCD display will be lit.

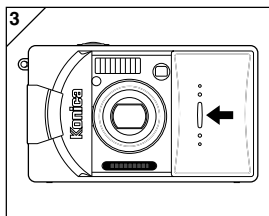

3. When you wish to turn the power OFF, slide the lens cover just a little in the direction indicated by the arrow. The power will turn OFF and the lens will retract. After you are sure the lens has fully retracted, you can close the lens cover to its fully closed position.

# Setting the Menu Language/Date and Time

- The first time that you use your camera, a screen will automatically appear and prompt you to set the time, date and language. To make those settings, please follow the steps below.
- You can select from among four languages, Japanese, English, French, and German.
- Make sure that either the AC adapter is connected or that there is enough battery power.

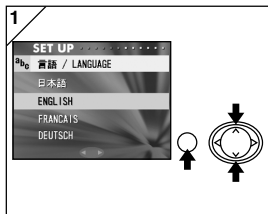

1. Turn the power on by either opening the lens cover or pressing the PLAY button.

The language selection screen will automatically appear on the LCD monitor. By pressing ▼ or ▲, select the desired language and push the MENU/SET button.

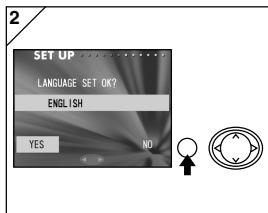

2. You will be prompted to confirm your language selection; confirm the selected “YES” by pressing the MENU/SET button.
  - If you select “NO” with ► and press the MENU/SET button, the current setting is invalidated and you will return to the first screen.

\* Once you have finished language selection, the next screen “DATE SET” will appear.

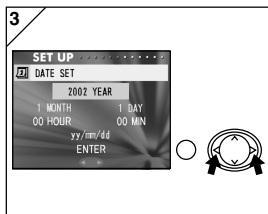

3. With “YEAR” selected, use ◀ or ▶ to adjust to the appropriate year.

The date may be adjusted up to Dec. 31, 2050.



# Setting the Menu Language/Date and Time (Cont'd)

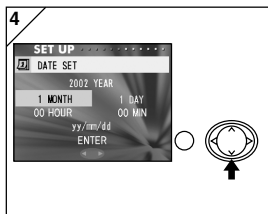

4. (1) Once the “YEAR” has been adjusted, press ▼ to move to the “MONTH” setting mode.

(2) Use ◀ or ▶ to adjust the month in the same way as Step 3 on page 24.

- By repeating procedures (1) and (2) above, adjust the date-and-time setting, and set the date format.
- The date format can be selected from among three patterns: yy/mm/dd, dd/mm/yy, and mm/dd/yy.
- By using ▲, you can return to the previous screen and make corrections.

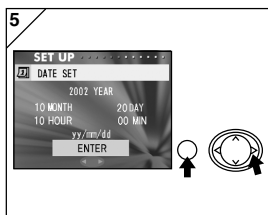

5. Once you have finished making all of the settings, select “ENTER” and press either ▶ or the MENU/SET button.

- If you select “ENTER” and press ◀, it invalidates the current settings and returns you to screen 3.

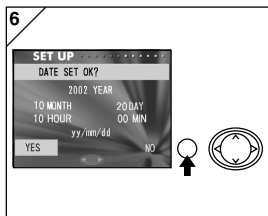

6. The date confirmation screen appears with “YES” selected. Press the MENU/SET button and the settings are complete.

- If you select “NO” with ▶ and press the MENU/SET button, the current settings are invalidated and you will return to screen 3.

7. After finishing the settings...

- If you turned the power ON with the main switch (by opening the lens cover), you can take pictures once the lens has reached its extended position.
- If you made the settings after pressing the PLAY button, the LCD monitor will display playback images.
- \* The internal clock is maintained by a back-up battery. Without a battery in the camera, the information will be maintained for about 24 hours. If the battery is removed for some time, you may have to reset the information (p.90).
- \* Do not remove the battery from the camera for at least three hours after making new date-and-time settings. They will be lost if the back-up battery is not fully charged.

# Inserting/Removing Cards

- About 2 MB of memory are built into this camera as recording media for image data, and other information, such as date and time, so even without a card inserted, the camera can record in an emergency. If you wish to use an aftermarket card, any of the following are appropriate: SD Memory Card, Multi-Media Card, Memory Stick. (All three will be called “card” hereafter.)
- First, turn OFF the main switch (lens cover closed), make sure the LCD monitor is OFF and turn off all power. If power is ON, damage may occur to the card or to the camera itself.

Under the factory default, the built-in memory has a demo picture of the world map in it, leaving only about 1 MB of memory capacity. To erase this image, follow the steps below.

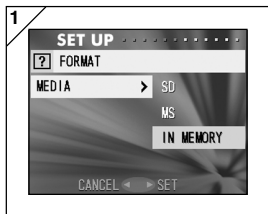

1. Select “FORMAT” from the set-up menu and choose “IN MEMORY” (page 87)
2. On Screen 1, while pressing the DELETE button, press MENU/SET button.
3. Once formatting starts, the message “NOW FORMAT...” will appear. When formatting is completed, the camera returns to the set-up menu.

- This procedure erases all images from built-in memory.

## Inserting a Card

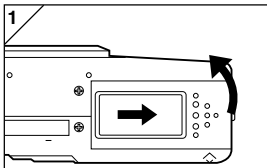

1. Open the battery/card cover.

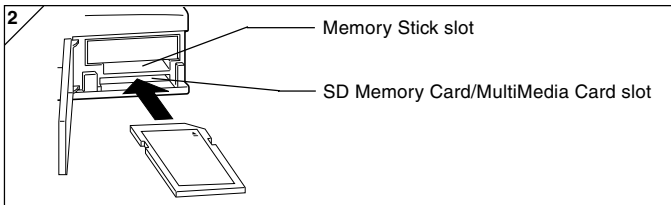

2. With the camera and the label of the card facing up, insert the card with the knocked out part first into the slot and push in until a click is heard.
- Take care that the card is inserted facing the right way. If the card is forcefully inserted facing the wrong way, it will damage the connector.
  - There are two card slots. When a SD Memory card or MultiMedia Card are used, insert them in the slot at the back of the camera, and if a Memory Stick is used, insert it in the slot toward the front.
3. Close the battery/card cover.

## Inserting/Removing Cards (Cont'd)

### Card Removal

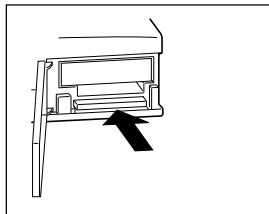

1. Open the battery/card cover.
2. If you gently push in on the card, the lock will release and the card will come out a little. Then carefully draw the card out.
3. Again, close the battery/card cover.

**Warning!** Insert or remove cards only after making sure that absolutely all power is OFF as indicated by the viewfinder LED being off.

While the card is being accessed, or an image is being processed, the LCD monitor will show "Now COPY...", etc., and the red LED will come on.

If you open the battery/card cover while the red LED is flashing, image processing may be interrupted or hindered.

While the red LED is still lit, make sure that you DO NOT open the battery/card cover.

- When a card is inserted, it is recorded on first. (When a card is not inserted, internal memory is used for recording. However, in this case the recording image size is limited to only 640 × 480 pixels.)
- Also, it is possible to insert and use two cards simultaneously, such as an SD memory card (or multi-media card) and a Memory Stick. In this case the card being used will be recorded on first. By using the Setup menu, you can select which to record to first (p.92).

### Holding Your Camera

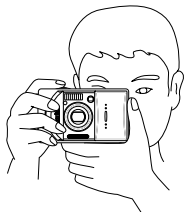

- Hold the camera securely with both hands and your elbows against your body for a stable position.
- To take a vertical picture, hold the camera so that the flash is at the top.

Please be careful that your fingers, hair, or the strap do not cover the lens, flash, or the light sensor.

### Viewfinder and Indicator LEDs

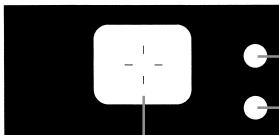

#### Viewfinder LEDs (→ p.30)

Green LED

Red LED

#### Auto-focus Mark

Align the crosshairs on the subject of your picture.

- In the macro-photo mode (p.41), we recommend that you use the LCD monitor for composing your pictures (p.35). If you use the viewfinder, what you can see and what the camera records may be different.

# Taking Pictures (Cont'd)

## Viewfinder LED Indicators

When the LED Indicators light, they mean the following:

- Green LED: (On) Camera ready to shoot (Flash does not fire)  
(Flashing) Warning that the camera cannot auto-focus (AF)
- Red LED: (On) Flash charging, Formatting the card  
(Flashing) Warning that your hands are shaking
- Both Red and Green LEDs:  
(On) Camera ready to shoot (Flash fires)  
USB cable is being connected  
(Flashing) System error; Card has insufficient memory, is faulty,  
not formatted; Insufficient battery warning  
(Green LED flashing/Red LED on)  
Card being accessed, images being processed,  
compressed/expanded, other processing

## Taking Pictures using the Viewfinder

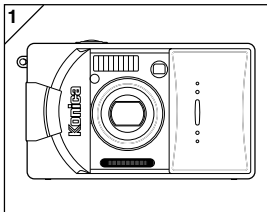

1. Opening the lens cover turns ON the power.

When the power comes ON, the LCD monitor will be on. If you will be using the viewfinder, to conserve your battery, press the DISPLAY button and the LCD monitor will turn off.

- If the surface of the lens is dirty, gently wipe it clean with a soft, dry cloth.

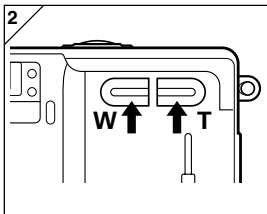

2. Looking through the viewfinder, compose the photo you wish to take and determine the size of the subject using the zoom buttons. Also, put the auto focus mark on the subject you wish to bring into focus.

- If you press the TELE (Telephoto) Zoom button, the camera zooms in, while if you press the WIDE (Wide-angle) button, it zooms out.
- If the subject you wish to focus on is not in the screen center, use "Shooting with Focus Lock" (p.34).

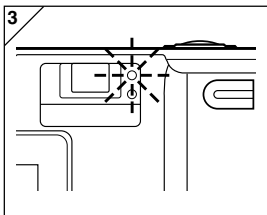

3. Press the shutter button half way and the green LED will light, indicating that the focus and exposure are locked.

- If it is difficult to focus, the green LED will flash. See page 33.
- If the camera senses your shaking, the red viewfinder LED will flash.

## Taking Pictures (Cont'd)

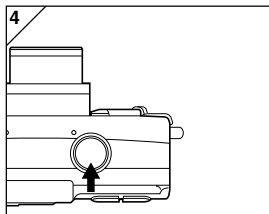

4. Take a picture by pressing the shutter button further. When it makes a sound, the shot has been taken, and the image will be recorded on the card (or built-in memory).
- The beep will not sound if the beeper setting is turned off (p.90).

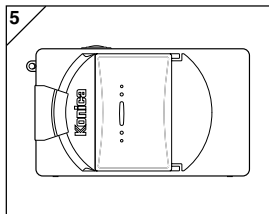

5. During recording to the card, the red LED and the self-timer LED on the front of the camera will come on, and the green LED will flash.
- While the red LED is lit and the green LED is flashing, you cannot otherwise operate the camera.
- Once the red and green LEDs disappear, the recording has finished.



**Do not open the battery/card cover while the red and green LEDs are flashing.**

6. When you are finished taking pictures, close the lens cover and turn OFF the power supply.

### Daytime (normal) shooting distances

Focal Length	Shooting Distance
Wide-angle*	0.5m (1.6ft) to ∞
Telephoto**	0.8m (2.6ft) to ∞

\* Equivalent to 39mm in 35mm camera conversion

\*\*Equivalent to 117mm in 35mm camera conversion

- If you wish to take a picture of a subject closer than the above ranges, use the macro-photo mode (pp.38, 41).



## Taking Pictures (Cont'd)

### **When you press the shutter halfway and the green LED flashes...**

This may suggest that the focusing on the subject is difficult, and/or the subject is too dark. Should this be the case, please take the following steps.

- Make sure that the camera is not too close to the subject, then align the subject to the auto-focus mark in the center of the viewfinder. (For the shooting distance, see page 32.)
- If the subject is too dark (such as a person in the shade), use the flash (pp.38-40).
- Use a similar subject, at the same distance and with the same brightness, to adjust the auto focus and exposure. After the focus lock is set, aim at your original subject and shoot your picture (p.34).

# Taking Pictures (Cont'd)

## Shooting with Focus Lock

- If the subject you wish to focus on is not in the center of the screen, use the focus lock mode.

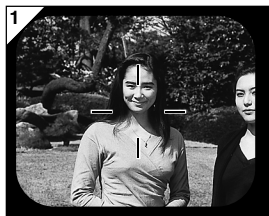

1. Align the auto focus mark on the subject, and push the shutter button half-way. The green LED light will come on, locking the focus position.

- The exposure is fixed at the same time the focus is locked.
- If you release your finger from the half-pushed shutter button, the focus lock will be released and you can repeat the procedure.



2. With the shutter button pressed half-way, re-compose your photo and press the shutter button all the way to take the picture.

- When re-composing the photo, do not change the shooting distance. If the distance has changed, repeat the procedure.

### The following subjects may be difficult to bring into focus:

- Subjects with no contrast (variance in brightness, e.g., the sky, a white wall, the hood of a car)
- Subjects with only horizontal lines and no surface texture
- Quickly moving subjects
- Poorly lit subjects (in a dark place)
- Subjects with a strong light or reflected light behind them
- Subjects in a flickering light, such as a fluorescent light

In the above circumstances, take your picture after the focus lock is set to the same distance and brightness as the subject.

# Taking Pictures (Cont'd)

## Taking Pictures using the LCD Monitor

- You can take a picture while looking at the LCD monitor as through the viewfinder.
- Using the LCD monitor consumes battery power at a high rate, so it is recommended to have a spare charged battery on hand (sold separately, model # DR-LB4), or to use the AC adapter (sold separately, model # DR-AC4).



1. Once the power supply is turned on by opening the lens cover, the LCD monitor will come on, and a through image (the image taken through the lens) will be projected.
2. While looking at the LCD monitor, compose and take your photo.
  - The shooting procedures are the same as "Taking a picture using the viewfinder" (pp.31-32).
  - When the writing process to the card is completed, the through image will reappear.

# Taking Pictures (Cont'd)

## Image Display

Shooting with the LCD monitor displays the picture and the following other information:

- You can set the camera so information is not displayed (p.89).

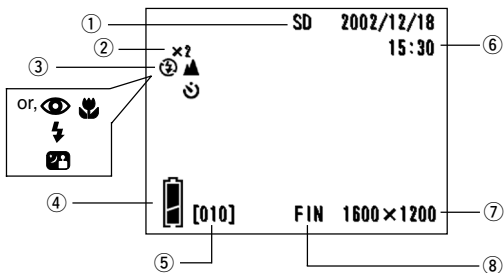

### ① Recording Media Display

This shows the media type.

- SD Memory Card or MultiMedia Card : SD\*
- Memory Stick : MS
- Built-in Memory : IN

\* Even when a Multi Media Card is used, the type will be displayed as SD.

### ② Digital Zoom Magnification

This will be displayed when the digital zoom function is used (p.55).

### ③ Shooting Mode

The selected shooting mode\*\* will be displayed.

\*\*For details on each shooting mode, see pages 38 to 41.

### ④ Battery Remaining Display

If the battery is being used, the remaining battery power will be displayed in two levels (p.19).

### ⑤ Counter

The remaining number of pictures you can take will be displayed.

### ⑥ Shooting Date and Time

The date and time of the shooting will be displayed.

### ⑦ Picture Size

The picture size of the photo being taken will be displayed.

### ⑧ Picture Quality Mode

- 1) Normally the photo quality of the picture being taken is displayed.
- 2) When shooting a movie,  is displayed.

### About Auto Power Off Function

If you do not operate for a certain period of time with the camera power on and the lens cover open, the auto power off function (pause status) will be activated and power will be turned off (with the lens still out).

By pressing the shutter button, zoom button, or another button, the camera will return to the shooting mode.

- When finished shooting, or if you are not going to take a picture for a long time, close the lens cover.
- The default auto power off time is set at three minutes. This can be changed in the set-up menu (p.91).
- When using an AC adapter, the auto power off function will be activated.



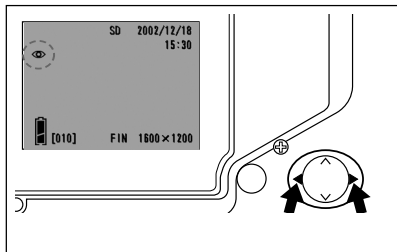

# Selecting the Shooting Mode

- Selecting different shooting modes enables you to create the best shooting condition for your subject.
- Once a mode is set (apart from the self-timer), you can shoot continuously. It is recommended that the mode should be returned to AUTO mode (no display) after shooting.
- The self-timer mode cancels the mode after each picture is taken.
- Also, when you turn the camera OFF, the shooting mode you set is canceled and the camera automatically returns to AUTO-mode shooting operation (no display). But the flash-mode setting remains in effect even if you switch the power OFF and back ON.







1. Turn the power on so that the LCD monitor is lit.
2. By pressing ◀ or ▶, bring up the desired shooting mode symbol on the LCD monitor.

Pressing ▶ enables the selection of the following modes.

- 1) AUTO (Automatic Flash) (p.39)
- 2)  Red Eye Reduction (p.39)
- 3)  Fill-In (p.40)
- 4)  Slow Sync (p.40)
- 5)  Off (Flash Override) (p.40)

• Every time ▶ is pressed, the mode symbol will be displayed one by one, through the list.

Pressing ◀ enables the selection of the following modes.

- 1) AUTO mode (no display)
- 2)  Macro-photo mode (p.41)
- 3)  Distant View mode (p.41)
- 4)  Self-Timer mode (p.41)
- 5)  Self-Timer + Macro-photo mode
- 6)  Self-Timer + Distant View mode

• Every time ◀ is pressed, the mode symbol will be displayed one by one, through the list.

# Selecting the Shooting Mode (Cont'd)

## Switching the Flash Mode

### AUTO (Auto Flash)

- This is the normal mode. When the camera is turned ON, it is set at Auto (Auto Flash). No symbol will be displayed on the LCD monitor.
- The flash will operate automatically when it is dark.
  - The red light after the flash indicates charging; while it is lit, you cannot take a picture.
  - The shutter speed when flash is used is about max. 1/60 sec. Be careful not to shake when pressing the shutter.
  - It is best to use the red-eye reduction when using a flash with people.

### Flash Shooting Distances

Focus Distance	Shooting Distance
Wide-Angle *	0.5m (1.6ft) to 3.5m (9.9ft)
Telephoto **	0.5m (1.6ft) to 2.0m (6.6ft)

\* Equivalent to 39 mm in 35mm camera conversion

\*\*Equivalent to 117mm in 35mm camera conversion

- If the shooting range is not in the above range, the picture may appear too bright when it is too close, and the picture may appear dark without enough lighting when it is too far. It is recommended you check the photo with the LCD monitor after shooting.

### Red-Eye Reduction

- Using this mode can reduce the “red-eye phenomenon”, which is people with red glaring eyes caused by the flash.
- When you press the shutter button, the pre-flash comes on, followed by the real flash which finishes the shot.
  - Until the real flash comes on, do not move the camera or let the subject move.
  - If the subject is not facing the pre-flash or final flash, or the distance to the subject is too far, the red-eye reduction effect may not be apparent.
  - The flash is in the AUTO flash mode and will not come on in a bright place.

## Selecting the Shooting Mode (Cont'd)

### **Fill-In**

- Use this mode when a shadow falls on the subject's face due to shade or artificial lighting, or when taking a picture against the light.
- Regardless of the brightness of the surroundings, the flash will always come on.

### **Slow-Sync**

- Use this mode when shooting a subject with a background of a night or evening view.
- Shooting with a flash is possible with a slow shutter speed.
  - Shutter speeds will be slower, so use a tripod to prevent shaking.
  - If the subject is moving, the picture will be blurred.

### **Off (Flash Override)**

- Use this mode for places (such as museum) where flash is prohibited, or when taking a picture of a night view, or taking a picture using indoor lighting.
- The flash will not come on even when it is dark.
  - Use a tripod to prevent shaking as shutter speeds are slower in the dark.
  - If the red LED comes on when the shutter button pressed half-way, this is a warning that the lighting is not sufficient and the resulting picture will be dark.



# Selecting the Shooting Mode (Cont'd)

## Shooting Close Up/Long Range

### Macro-photo Mode

- Use this mode when you want to be close to the subject.
- If the distance between the camera and the subject is close, there will be a difference between the image in the viewfinder and the picture that is actually taken. It is recommended that the LCD monitor be used.
  - Use a tripod to prevent shaking as shutter speeds are slower when taking close-ups.
  - The self-timer function can be used in conjunction with this function for shooting.

### Macro-photo Mode Shooting Distances

Focus Distance	Shooting Distance
Wide-Angle	0.1m (0.3ft) to ∞
Telephoto	0.5m (1.6ft) to ∞

### Distant View Mode

- Use this mode when shooting a distant subject, such as scenery or buildings.
  - Always use a tripod.
  - The flash will not come on.
  - The self-timer function can be used in conjunction with this function for shooting.

## Using the Self-Timer

### Self-Timer Mode

- Use a tripod.
- When the shutter button is pressed, the self-timer LED comes on, and after 10 seconds, a picture will be shot.
  - If you wish to cancel the self-timer function, close the lens cover.
  - After the picture is taken, the mode will be cancelled. If you wish to use the self-timer repeatedly, set the mode every time you take a picture.
  - The activation time for the self-timer can be set at “3 Seconds” by using the set-up menu (p.90).

- By using the REC menu, you can take pictures with your desired settings. You can set the camera using the “REC (BASIC) menu” (default setting), or “REC (DETAILS)” (p.49).
- The settings made with each menu will be maintained, even when power is turned off, until the settings are changed, unless otherwise described.

### Setting with the REC (BASIC) Menu

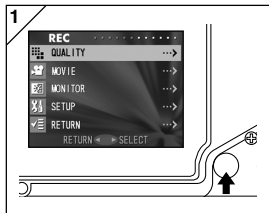

1. Turn the power ON, with the LCD monitor on (through image display). Pressing the MENU/SET button will display the REC menu screen.

2. Select the menu you wish to set by pressing ▼ or ▲. Every time the button is pressed, the menu mode changes as follows;

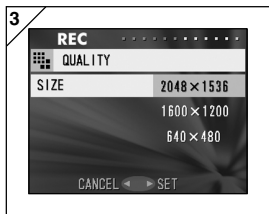

3. After selecting the menu, pressing ► will display the set-up screen (screen 3) of the menu. After selecting the desired content with ▼ or ▲, pressing ► or the MENU/SET button will complete the set-up and will return you to screen 1.

4. Pressing the ◀, or pressing the MENU/SET button after selecting “RETURN” with screen 1 (REC menu screen) will complete the REC menu and return to the through image (picture shooting mode).
  - For details of each set-up menu, refer to the pages hereafter.

# Using the REC Menu (Cont'd)

## Selecting the Image Size

- You can select from among three image sizes.
- All on the same card, you can choose a different image size for every picture. Every time you change the image size, the number of remaining photos also changes, which is displayed on the LCD monitor.

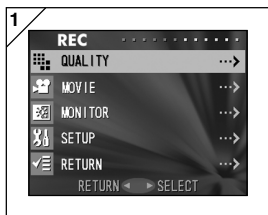

1. Select "QUALITY" and press ►.



2. Choose the desired picture size using ▼ or ▲ and enter your selection with ► or by pressing the MENU/SET button. After selecting the size, you will return to screen 1.
  - If you press ◀, the selection is invalidated and you will return to screen 1.

## Using the REC Menu (Cont'd)

### Image size and pixel count (width) × (height)

**1) 2048 × 1536 pixels (approximately 3,140,000 pixels)**

This is the highest quality image. Use this mode for important pictures you want to keep, for images you want to edit on your computer, etc. As it is the largest, it is also ideal for printing out your enlarged photos.

**2) 1600 × 1200 pixels (approximately 1,920,000 pixels)**

This mode is a good standard setting when you want to view memorable photos on your computer screen, or for printing them out.

**3) 640 × 480 pixels (approximately 300,000 pixels)**

As this mode produces the smallest file size, it is best for sending via email, for use in home pages, etc.

### Standard number of pictures you can take of each size (without movie)

Image Size	Using a 64 MB SD Memory Card	Internal Memory
2048 × 1536	About 98 photos	—
1600 × 1200	About 213 photos	—
640 × 480	About 640 photos	About 20 photos

- The number of photos you can take varies depending on the subject .
- When there are files other than images, or when the quality and/or recording mode have been changed, the number of photos you can take is not limited to the table above. Please use the table as a guide for the number of photos you can take.
- You can also mix the different image sizes and the 2 compression rates (p. 51).

# Using the REC Menu (Cont'd)

## Shooting Movies

- Set your camera to this mode to shoot movies.
- You can take a movie for approximately 15 seconds. Your camera records an image with a 320 × 240 pixel count.
- While you are shooting a movie, the LCD monitor stay on. Even if you press the DISPLAY button, the LCD monitor will not turn off. Please view the LCD monitor while shooting your movies.

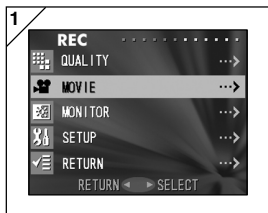

1. Select “MOVIE” and press ►.

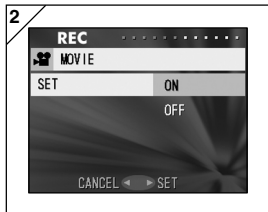

2. Select “ON” with ▼ or ▲ and enter your selection with either ► or by pressing the MENU/SET button.
  - If you press ◀, the selection is invalidated and you will return to screen 1.
  - If you select “OFF” and press either ► or the MENU/SET button, you will return to screen 1.

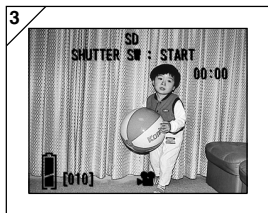

3. The display returns to the through image, with movie information displayed as in screen 3. In this screen you can start taking a movie.

## Using the REC Menu (Cont'd)

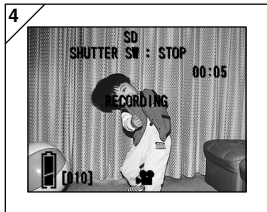

4. When you press the shutter button, your movie will start recording. You can record for about 15 seconds.
- You need not hold the shutter button down.
  - When the remaining time runs out, the camera stops recording automatically. If you wish to stop while the camera is recording, simply press the shutter button again.
  - The elapsed time is displayed on the upper right of the screen.

- NOTE: 1) As long as the camera's power is ON, you can continue to take movies, but if you turn the power off, it exits the movie mode. If you turn the power back ON and wish to shoot another movie, reset the camera to the movie mode.
- 2) Once you have pushed the shutter button, and started taking a movie, you cannot use the optical zoom.
- 3) The digital zoom is also inoperable.

# Using the REC Menu (Cont'd)

## Adjusting the Brightness of the LCD Monitor

- You can adjust the brightness of the LCD monitor to suit your shooting location.

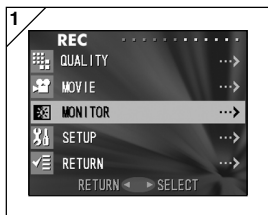

1. Select “MONITOR” and press ►.



2. The through image mode is entered and on the bottom of the screen the brightness adjustment bar appears.

If you press ►, the cursor moves to the plus side and the screen gets brighter. Pressing ◀ produces the opposite result—the cursor moves toward the minus side and the screen darkens. Choose the best brightness setting for you and press the MENU/SET button. You will then return to screen 1.

# Using the REC Menu (Cont'd)

## Selecting the Set-up Menu

- By setting each item on the set-up menu to your preferences, you can customize your camera to suit you.

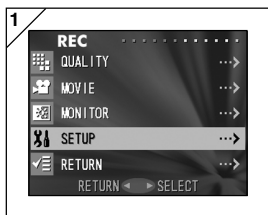

1. Select "SETUP" and press ►.

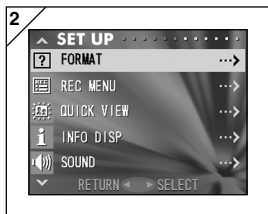

2. You will enter the SET UP Menu mode. For details, see "Using the Set-up Menu" on page 86.



# Using the REC Menu (Cont'd)

## Setting with the REC (DETAILS) Menu

- If you set your camera to REC (DETAILS) menu mode in advance, you can make most of the menu settings. See page 88 for how to make mode settings.
- Similarly, to learn how to enter the REC menu screens and how to select menus, refer to “Setting with the REC (BASIC) Menu” on page 42.
- In the REC (DETAILS) menu mode, every time you press the ▼ or ▲ button the menu cycles through the following screens:

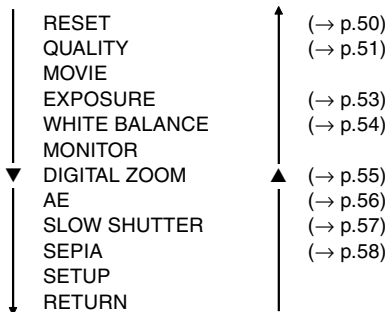

- When you are on a REC Menu screen, if you press ◀ or “RETURN” followed by the MENU/SET button, you will leave the REC Menu mode and return to the through image mode (picture shooting mode).
- The following menus are explained in the same way under “Setting with the REC (BASIC) Menu”. (See the pages below for the appropriate explanation.)
  - MOVIE (→ p.45)
  - MONITOR (→ p.47)
  - SETUP (→ p.48)

# Using the REC Menu (Cont'd)

## Returning to Default Settings

- You can easily change all the settings you made in the REC menu back to their initial settings.



1. Select "RESET" and press ►.

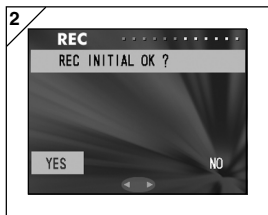

2. A confirmation screen will appear. To change settings back, use ◀ or ▶ to select "YES" and press the MENU/SET button. The settings are completed and you will return to screen 1.
- If you select "NO" and press the MENU/SET button, you will return to screen 1 without any changes to your settings.

# Using the REC Menu (Cont'd)

## Selecting a Combination of Image Sizes and Compression Ratios

- You can select a combination of three image sizes and two compression ratios.
- While using the same card, you can change the picture quality settings for every photo. Every time you change the picture quality, the number of images remaining will change and be displayed on the LCD monitor.
- When quality is the priority, select "FINE"; when the number of photos is more important, select "NORMAL".

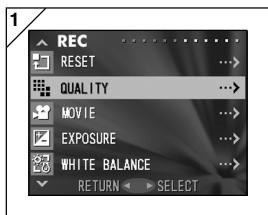

1. Select "QUALITY" and press ►.



2. Use ▼ or ▲ to select image size or compressions ratio, then press ►.

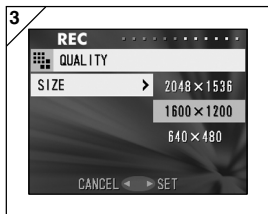

3. **Select the picture size**

Use ▼ or ▲ to select the desired image size, then press either ► or the MENU/SET button. You will return to screen 2 with your chosen size displayed.

- If you press ◀, the setting is invalidated and you will return to screen 2.

## Using the REC Menu (Cont'd)



### Selecting the Compression Ratio

Use ▼ or ▲ to select the desired compression ratio, then press either ► or the MENU/SET button. You will return to screen 2 with your chosen compression ratio displayed.

- If you press ◀, the setting is invalidated and you will return to screen 2.

### Standard number of pictures you can take in each quality mode (without movie)

Image Size	Compression Ratio	64 MB SD Memory Card	Internal Memory
2048 × 1536	FINE	About 49 Photos	—
	NORMAL	About 98 Photos	—
1600 × 1200	FINE	About 106 Photos	—
	NORMAL	About 213 Photos	—
640 × 480	FINE	About 320 Photos	About 10 Photos
	NORMAL	About 640 Photos	About 20 Photos

- The number of photos you can take may vary depending on the subject.
- When there are files other than images, or when the quality and/or recording mode have been changed, the number of photos you can take is not limited to the table above. Please use the table as a guide for the number of photos you can take.

# Using the REC Menu (Cont'd)

## Adjusting Exposure Compensation

- If you wish to brighten or darken an entire image, use the exposure adjustment function.
- The exposure can be corrected  $\pm 1.5$  EV in adjustment steps of 0.3 EV.

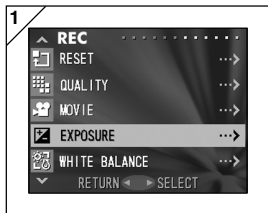

1. Select "EXPOSURE" and press ►.



2. The through image mode is entered, and the adjusting exposure compensation bar is displayed. If you press ►, the cursor moves toward the plus side while pressing ◀ moves it toward the minus. Select the desired compensation level (brightness) and press the MENU/SET button. The setting is completed and you will return to screen 1.

- Even after a correction, there are times when the change is not apparent, such as when the subject is in a semi-dark place.
- When flash is used, the compensation effect may not be sufficient.
- The compensation setting always resets to default values when you turn the camera OFF.

# Using the REC Menu (Cont'd)

## Adjusting White Balance

- The colour tone of your photos will change according to the kind of light source. While the AUTO mode can be used in almost all instances, you can alter the white balance settings to suit the environment and lighting when you take a picture.

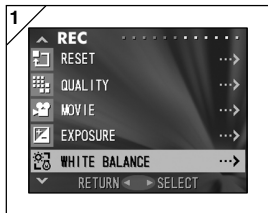

1. Select "WHITE BALANCE" and press ►.

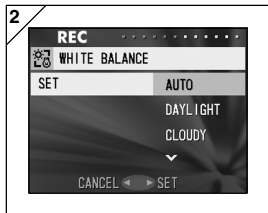

2. Use ▼ or ▲ to select the desired mode, then press either ► or the MENU/SET button. The setting is completed and you will return to screen 1.
  - If you press ◀, the selection is invalidated and you will return to screen 1.
  - The setting always resets to AUTO when you turn the camera OFF.

## Available Modes

- **AUTO (Default)** : The camera adjusts the white balance automatically.
- **DAY LIGHT** : Ideal for taking photos in strong sunlight.
- **CLOUDY** : Ideal for taking photos in the shade or when it is cloudy.
- **FLUO** : Ideal for taking photos indoors with fluorescent lighting.
- **TUNGSTEN** : Ideal for taking photos indoors with normal incandescent lighting.

## About White Balance

The human eye has the ability to compensate so that it sees white subjects as white, whatever the light source. Digital cameras and similar devices can also "see" white subjects as white by first adjusting the colour balance of the ambient light to match the photo subject. This adjustment is called the White Balance.

# Using the REC Menu (Cont'd)

## Using the Digital Zoom

- Digital zoom can double the largest zoom ratio achieved by the optical zoom.
- When using the digital zoom, view the field through the LCD monitor. Because the zoom effect is accomplished electronically, it is not possible to use the viewfinder.
- When shooting movies, the digital zoom function is not available.

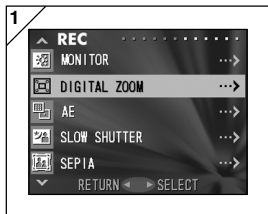

1. Select "DIGITAL ZOOM" and press ►.

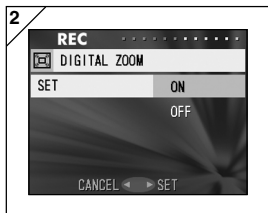

2. Use ▼ or ▲ to select "ON", then press either ► or the MENU/SET button. The setting is completed and you will return to screen 1.
  - If you press ◀, the selection is invalidated and you will return to screen 1.

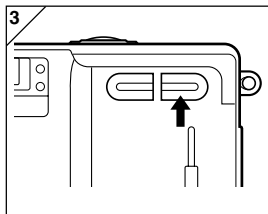

3. From screen one, when you press ◀, you will return to the through image mode. To take a picture, press the TELE zoom button until it reaches the end of the optical range, then release the button for a moment, then press and hold the TELE zoom button and the digital zoom is engaged. Use the LCD monitor to compose your photo, and take your photos.
  - The LCD monitor will display the digital zoom ratio (×2).
  - To return to normal mode, press the WIDE zoom button.

# Using the REC Menu (Cont'd)

## Changing Auto-Exposure (AE) Modes

- Your camera uses center-weighted metering as the default, but it can be changed to spot metering.
- Spot metering is used to ensure matching the exposure to a targeted part of your subject.

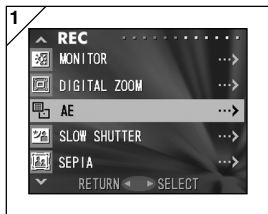

1. Select "AE" and press ►.

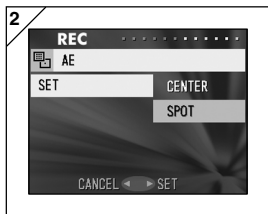

2. Use ▼ or ▲ to select "SPOT", then press either ► or the MENU/SET button. When the setting is completed, you will return to screen 1.
  - If you press ◀, the selection is invalidated and you will return to screen 1.

## Center-weighted metering

In this mode the camera sets the exposure according to the metering for the central part of the whole frame. It is ideal for taking photos where the brightness of the subject in the center of the frame is desired.

## Spot metering

In spot metering the camera measures the light of just the subject in the center of the frame, and sets the exposure to it. This mode is ideal when the background of the picture is brighter than the subject, or there is a great deal of contrast between the two, as the camera allows you to take the photo with the exposure set to the brightness of your desired subject.



# Using the REC Menu (Cont'd)

## Changing to the Slow Shutter Speed Mode

- The normal (default setting) shutter speed ranges between 1/8<sup>th</sup> to 1/2000<sup>th</sup> of a second, but this can be changed to a range of 1 second to 1/2000<sup>th</sup> of a second.
- When taking photos in dark locations, the shutter speed must be slow, so use a tripod to keep the camera steady.

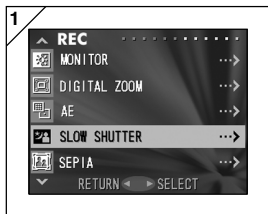

1. Select “SLOW SHUTTER” and press ►.

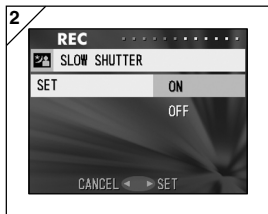

2. Use ▼ or ▲ to select “ON”, then press either ► or the MENU/SET button. When the setting is completed, you will return to screen 1.
  - If you press ◀, the selection is invalidated and you will return to screen 1.

- **Slow shutter speed is only in effect whilst in “Slow-Sync”/“Off”/“Distant View” modes. When in a dark location, use a tripod to keep the camera steady.**
- **To return to normal shutter speeds, change the setting back to off.**

# Using the REC Menu (Cont'd)

## Taking Sepia Tone Photos

- You can take sepia tone photos.

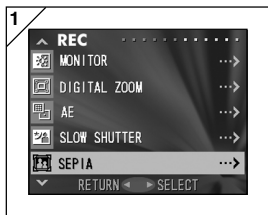

1. Select "SEPIA" and press ►.

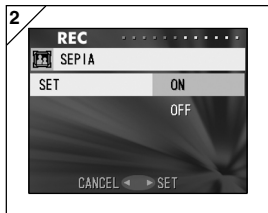

2. Use ▼ or ▲ to select "ON", then press either ► or the MENU/SET button. When the setting is completed, you will return to screen 1.

- If you press ◀, the selection is invalidated and you will return to screen 1.

**Playing Back Pre-recorded Images**

- You can play back pre-recorded images on the LCD monitor.
- When you play back images, it doesn't matter whether the camera's power is OFF or ON.
- Just in case battery power runs low, have a spare charged battery pack (sold separately, DR-LB4) on hand. Alternatively, using the AC adapter is recommended. (sold separately, model # DR-AC4)



1. Press the PLAY button and the last recorded photo will be played back on the LCD monitor.  
When the camera's power is OFF (with the lens cover closed), you can play back images by holding down the PLAY button for more than 2 seconds.
  - If there isn't any image data recorded, the message "NO DISPLAY DATA" will be displayed.
2. Every time you press ◀ or ▶, the previous or next photo will be played back.
  - When you have finished playing back photos, turn off the LCD monitor by pressing the PLAY button again to prevent battery consumption. Also, if you will not be taking any photos, close the lens cover, turning OFF the power.

## The Playback Image Display

In addition to the images you've taken, the following information is displayed.

- You can set the camera so information is not displayed (p.89).

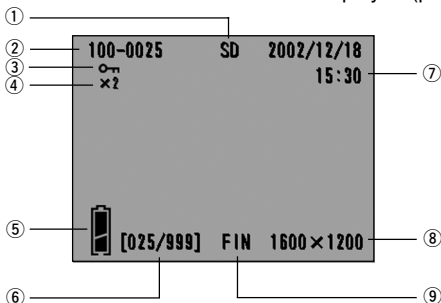

### 1 Recording Media Display

The type of media in use is displayed.

- The SD Memory Card or Multi-media Card\* :SD
- Memory Stick :MS
- Internal Memory :IN

\* Even if a Multi-media Card is used, "SD" will be displayed.

### 2 File Number

The file and directory numbers recorded in the card are displayed.

### 3 Protected Display

If an image is protected, the Protected symbol is displayed.

### 4 Digital Zoom Magnification

The magnification ratio is displayed when the digital zoom is in use.

### 5 Remaining Battery Power Display

When the battery is in use, the remaining power is displayed in two levels (p.19).

### 6 Image No. (Playback Frame No./ Total Frame No.)

Your camera is capable of playing back up to 999 frames. If there are more than 999 frames on a card, it is not possible to use playback.

### 7 Date & Time Recorded

- 1) Normally the time & date an image was recorded are displayed.
- 2) When movie images are played back, the playback time is displayed.

### 8 Image Size

Image size is displayed.

### 9 Picture quality mode

- 1) Normally the picture quality mode in use when the picture was shot is shown.
- 2) In movie images,  is displayed.

## Playing Back Movies

1

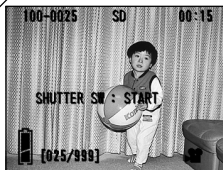

1. After pressing the PLAY button, use ◀ or ▶ to select the movie you wish to see.
  -  is displayed on the movie image.

2

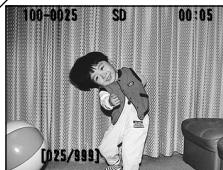

2. If you press the shutter button, the movie images will be played back. When playback is finished, the display returns to screen 1.
  - Symbols displayed when a movie is played back are recording media, file number, image number, and elapsed playback time only.
  - If you want to stop during playback, press the shutter button again.

## Playing Back Enlarged Images (Digital Zoom)

- You can play back your images as enlargements.



1. After pressing the PLAY button, use ◀ or ▶ to select the image you wish to see. Then use the TELE zoom button to zoom in; every time you press the TELE button, the image is enlarged further.

- The zoom ratio is displayed on the LCD monitor.
- To zoom back out, press the WIDE zoom button.

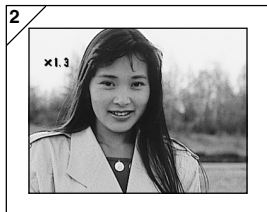

2. Use ◀, ▶, ▲, or ▼ to scroll around the photo to the part you want to see.

- To conserve your battery once you've finished viewing, press the PLAY button again to turn off the LCD monitor.

### Using the Quick-view Function

- If you pre-set the camera to the Quick-view mode (p. 88), you can review pictures on the LCD monitor right after you've taken them.



#### **When using the viewfinder to shoot images, with the LCD monitor off:**

After the LCD monitor displays the last image that you have taken, it will automatically turn back to off.

#### **When using the LCD monitor for shooting images:**

- 1) After you take a picture, the LCD monitor automatically displays it.
- 2) After about three seconds, the LCD monitor returns to the through image.

# Erasing the Playback Image

- You can erase playback images (one frame or all).
- You cannot erase protected images.
- Once an image is erased, it cannot be restored.

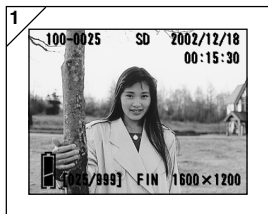

1. After pressing the PLAY button, use ◀ or ▶ to select the image you wish to erase.
  - If you wish to erase all frames, it doesn't matter which image is displayed.



2. Press the DELETE button and a screen appears indicating the media type to be erased and prompting you to select the frame range. Press ◀ or ▶ to select "THIS" (the selected image) or "ALL", and press the MENU/SET button.
  - If you decide not to erase a frame, select "CANCEL" or press the DELETE button again, then you will return to screen 1.

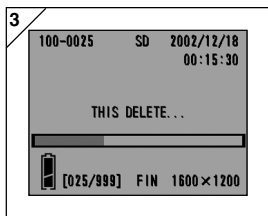

3. Once erasing starts, the "THIS DELETE..." screen is displayed. When the process is finished, the display returns to the playback image.
  - If there isn't any image data, "NO DISPLAY DATA" is displayed.
  - Once an image is erased, it cannot be restored.



- By using the PLAY menu, you can play back images, erase unwanted pictures and edit images.
- The camera's power can be OFF or ON.

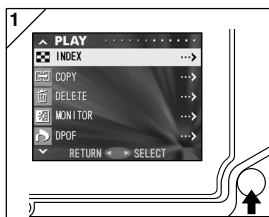

1. After pressing the PLAY button, press the MENU/SET button and the PLAY menu screen will be displayed.

2. Using ▼ or ▲, select the desired settings menu. Every time you press the button, the menu mode screen changes as follows:

↓	INDEX	↑	(→ p.66)
	COPY		(→ p.67)
	DELETE		(→ p.70)
	MONITOR		(→ p.73)
	DPOF		(→ p.74)
▼	RESIZE	▼	(→ p.78)
	PROTECT		(→ p.79)
	MOVE		(→ p.82)
	SLIDE SHOW		(→ p.85)
	SET UP		(→ p.85)
↓	RETURN		

3. After selecting the menu, press ► and in the same way as the REC menu (p.42), the setting screen of the selected menu will be displayed. After selecting the desired contents with ▼ or ▲, press either ► or the MENU/SET button, completing the setting, and you will return to screen 1.
4. When you are in screen 1 (PLAY menu screen), to exit the PLAY menu mode, press either ◀ or the MENU/SET button after selecting "RETURN". You will return to either the Playback or the through image mode. Press the PLAY button to turn off the LCD monitor.
  - For details on making settings for each menu, refer to the following pages.

# Using the PLAY Menu (Cont'd)

## Viewing Multiple Pages at Once (Index Playback)

- Up to nine frames can be displayed on the LCD monitor simultaneously. You can quickly access the images you want displayed. You can also erase unwanted images.

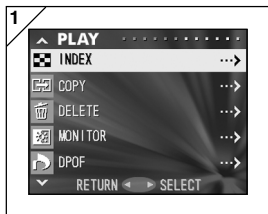

1. Select "INDEX" and press ►.

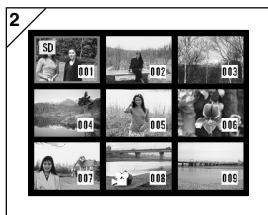

2. The 9-frame index are displayed at the same time. The image selected when you entered the menu will be surrounded by a red frame. Use ◀, ▶, ▲, or ▼ to move the frame and select the image you wish to display (or erase).

- Pressing ◀ when the first frame is selected or ▶ on the last frame will switch the screen to the next nine images.

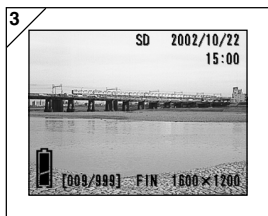

3. Press the MENU/SET button and the selected image will be displayed in the normal size.

If you wish to delete the selected image, press the DELETE button. After pressing the DELETE button, the procedures are the same as explained at Step 2 to 3 on page 64.

- If you wish to delete all the images on a card, it doesn't matter which image is displayed.

# Using the PLAY Menu (Cont'd)

## Copying an Image

- You can copy a previously recorded still photo or movie onto another memory media. (You can select one frame, multiple frames or all frames.)

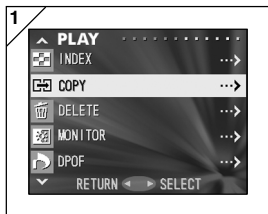

1. Select "COPY" and press ►.

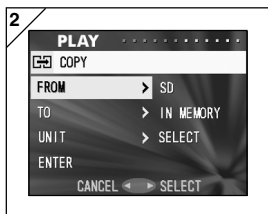

2. A screen with each setting item will appear. At first "FROM" is selected, so press ►.
  - To select a different item, press ▼ or ▲.

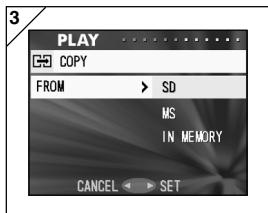

3. The media types will be displayed. Using ▼ or ▲, select the media on which the image you wish to copy is recorded, then press ► or the MENU/SET button. The setting is completed and you will return to screen 2.
  - If you press ◀, the setting is invalidated and you return to screen 2.
  - If there are no images on the media selected, or if a card is not inserted in the camera, you return to screen 3.

## Using the PLAY Menu (Cont'd)

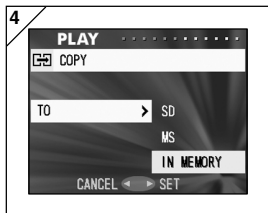

4. Returning to screen 2, select "TO". Then the screen shown left (screen 4) appears. After pressing ►, use ▼ or ▲ to select the destination media by pressing either ► or the MENU/SET button. The setting is completed and you will return to screen 2.
- If you press ◀, the setting is invalidated and you return to screen 2.
  - If the selected media doesn't have enough free space, an error message will appear, then you will return to screen 4.

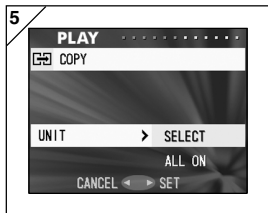

5. Returning to screen 2, select "UNIT". Then the screen shown left (screen 5) appears. After pressing ►, use ▼ or ▲ to choose "SELECT" (if one or multiple frames are to be selected) or "ALL". Then press either ► or the MENU/SET button, and the settings are completed, returning you to screen 2.
- If you press ◀, the setting is invalidated and you return to screen 2.

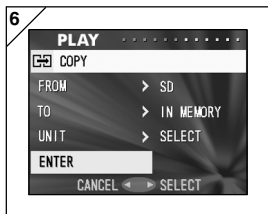

6. After you have made all the settings, select "ENTER" and press either ► or the MENU/SET button.
- If you chose "SELECT" on screen 5, go to Step 7; if you chose "ALL", go to Step 9.
  - If you press ◀, the setting is invalidated and you return to screen 1 on page 67.

## Using the PLAY Menu (Cont'd)

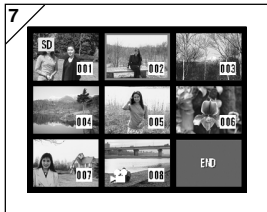

7. The 8-frame index appears. Using ◀, ▶, ▲, or ▼, move the red frame to an image you wish to select and press the MENU/SET button.

- Pressing ◀ when the first frame is selected or ▶ on the last frame will switch the screen to the next eight images.

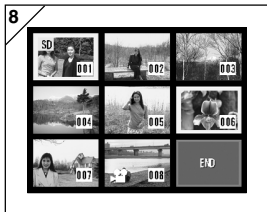

8. Images selected at Step 7 are surrounded by a yellow frame. When you have finished selecting images, use ◀, ▶, ▲, or ▼ to select “END”, and then press the MENU/SET button. (Go to Step 9)

To select other images, repeat the selection procedure. (Return to Step 7)

- To select multiple images, repeat the procedures Steps 7 and 8.



9. A confirmation screen appears. To carry out copying, select “YES” with ◀ or ▶, then press the MENU/SET button.

- If you select “NO” and press the MENU/SET button, you will return to screen 1 without making a copy.

10. Once copying starts, “Now COPY...” is displayed. Once copying is completed, the display returns to screen 1.

# Using the PLAY Menu (Cont'd)

## Erasing Unwanted Images

- You can erase unwanted still pictures, movie images etc. (you can select one frame, multiple frames or all frames.)
- Once images are erased, they cannot be recovered.
- Protected images cannot be erased unless the protection is removed.

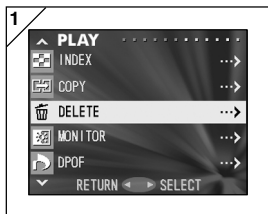

1. Select "DELETE" and press ►.

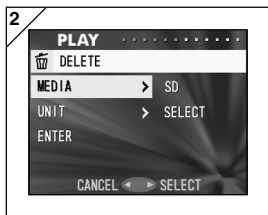

2. A screen with each setting item will appear. At first "MEDIA" is selected, so press ►.
  - To select a different item, press ▼ or ▲.

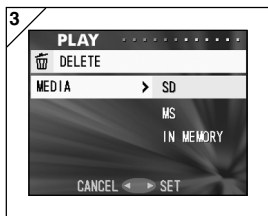

3. Using ▼ or ▲, select the media on which the image you wish to erase is recorded, then press ► or the MENU/SET button. The setting is completed and you will return to screen 2.
  - If you press ◀, the setting is invalidated and you return to screen 2.
  - If there are no images on the media selected, or if a card is not inserted in the camera, you return to screen 3.

## Using the PLAY Menu (Cont'd)

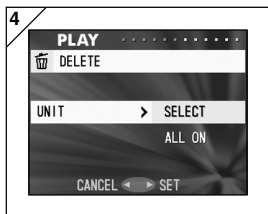

4. Returning to screen 2, select "UNIT". Then the screen shown left (screen 4) appears. After pressing **▶**, use **▼** or **▲** to choose "SELECT" (If one or multiple frames are to be selected) or "ALL". Then press either **▶** or the MENU/SET button. The settings are completed and you will return to screen 2.
- If you press **◀**, the setting will be invalidated and you will return to screen 2.

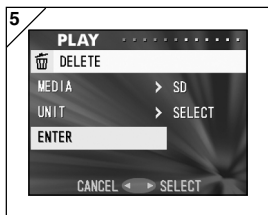

5. After you have made all the settings, select "ENTER" and press either **▶** or the MENU/SET button.
- If you chose "SELECT" on screen 4, go to Step 6; if you chose "ALL", go to Step 8 on page 72.
  - If you press **◀**, the setting is invalidated and you return to screen 1.

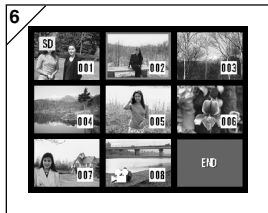

6. The 8-frame index appears. Using **◀**, **▶**, **▲**, or **▼**, move the red frame to an image you wish to erase and press the MENU/SET button.
- Pressing **◀** when the first frame is selected or **▶** on the last frame will switch the screen to the next eight images.

## Using the PLAY Menu (Cont'd)

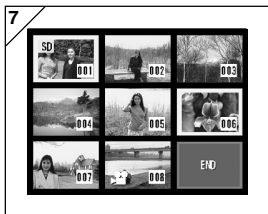

7. Images selected at Step 6 on page 71 are surrounded by a yellow frame. When you have finished selecting images, use ◀, ▶, ▲, or ▼ to select “END”, and then press the MENU/SET button. (Go to Step 8)

To select other images, repeat the selection procedure. (Return to Step 6)

- To select multiple images, repeat Steps 6 and 7.

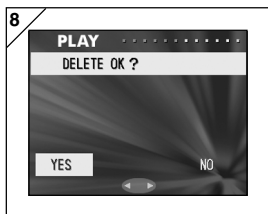

8. A confirmation screen appears. To carry out erasing, select “YES” with ◀ or ▶, then press the MENU/SET button.

- If you select “NO” and press the MENU/SET button, you will return to screen 1 without erasing anything.

9. Once erasing starts, “THIS DELETE...” is displayed. Once erasing is completed, the display returns to screen 1.



# Using the PLAY Menu (Cont'd)

## Adjusting LCD Monitor Brightness

- You can adjust the brightness of your LCD monitor as needed to suit the lighting where you are viewing images.
- Brightness settings are not altered by turning the power ON/OFF and are saved until changed again.



1. Select "MONITOR" and press ►.



2. The current playback image is displayed with the Monitor Brightness bar on the bottom of the screen.  
If you press ►, the cursor moves to the plus side and the screen gets brighter. Pressing ◀ produces the opposite result—the cursor moves toward the minus side and the screen darkens. Choose the best brightness setting for you and press the MENU/SET button. You will then return to screen 1.

# Using the PLAY Menu (Cont'd)

## Selecting/Deselecting Images to Print (DPOF)

- DPOF is short for Digital Print Order Format. DPOF is a format for recording information on memory cards, etc. so they can be used by DPOF compatible digital printers and lab print services for printing out images you've taken with your camera.
- You can select the frames (one frame, multiple frames or all frames) you want to print from all the still images you've taken. You can also deselect the settings. However, you cannot print movie images.
- When you print a photo you took previously, you can imprint the date (the date taken) onto the image. (You can also select not to imprint the date.)

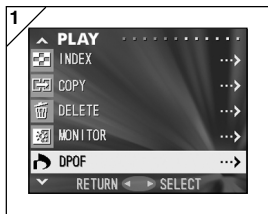

1. Select "DPOF" and press ►.

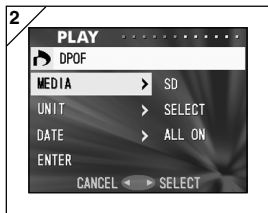

2. A screen with each setting item will appear. At first "MEDIA" is selected, so press ►.
  - To select a different item, press ▼ or ▲.

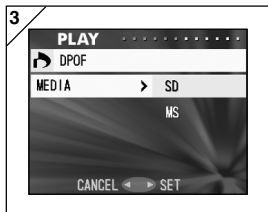

3. Using ▼ or ▲, select the media on which the image you wish to print (or deselect) is recorded, then press ► or the MENU/SET button. The setting is completed and you will return to screen 2.
  - If you press ◀, the setting is invalidated and you return to screen 2.
  - If there are no images on the media selected, or if a card is not inserted in the camera, you return to screen 3.

## Using the PLAY Menu (Cont'd)

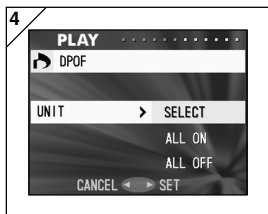

4. Returning to screen 2, select "UNIT". Then the screen shown left (screen 4) appears. After pressing ►, if you want to print (or deselect) one or multiple frames, use ▼ or ▲ to choose "SELECT". To print all frames, choose "ALL ON", or to deselect all frames from printing, choose "ALL OFF". After making your selection, press ► or the MENU/SET button. The settings are complete and you will return to screen 2.
- If you press ◀, the settings will be invalidated and you will return to screen 2.

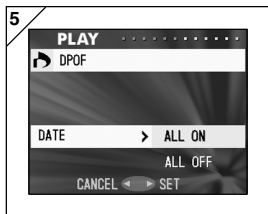

5. Select "DATE" on screen 2, and then press ►. If you wish to print the date, select "ALL ON" with ▼ or ▲, or if not, select "ALL OFF". After making your choice, press either ► or the MENU/SET button. The settings are complete and you return to screen 2.
- If you press ◀, the setting will be invalidated and you will return to screen 2.

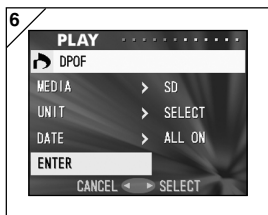

6. After you have made all the settings, select "ENTER" and press either ► or the MENU/SET button.
- If you chose "SELECT" for "UNIT" at on screen, go to Step 7; if you chose "ALL ON" or "ALL OFF" go to Step 9 on page 77.

## Using the PLAY Menu (Cont'd)

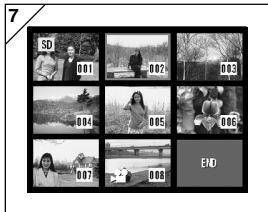

7. The 8-frame index appears. Using ◀, ▶, ▲, or ▼, move the red frame to an image you wish to print (or deselect) and press the MENU/SET button.

- Pressing ◀ when the first frame is selected or ▶ on the last frame will switch the screen to the next eight images.



8. Images selected at Step 7 are surrounded by a yellow frame. When you have finished selecting images, use ◀, ▶, ▲, or ▼ to select “END”, and then press the MENU/SET button. (Go to Step 9)

To select other images, repeat the selection procedure. (Return to Step 7)

- To select multiple images, repeat the procedures Steps 7 and 8.



9. A confirmation screen appears.

**If you chose “SELECT” or “ALL ON”:** Set the number of prints using ▲ or ▼. Next, select “YES” with ◀ or ▶ and press the MENU/SET button.

- You can print from 1 to 99 photos.
- If you select “NO” and press the MENU/SET button, your settings will be invalidated and you will return to screen 1.

**If you chose “ALL OFF”:** select “YES” and press the MENU/SET button.

- If you select “NO” and press the MENU/SET button, you will return to screen 1 without deselecting anything.



10. The “Now DPOF SET...” (or “Now DPOF OFF...”) screen is displayed. Once settings (or deselection) are completed, the display returns to screen 1.

# Using the PLAY Menu (Cont'd)

## Reducing Image Size (Resizing)

- You can reduce the size of images you have taken. When you resize an image, a new, smaller file is created.
- Use this function when you send images as e-mail attachments or when you otherwise need a smaller image.
- The resize function is not available for movie images.

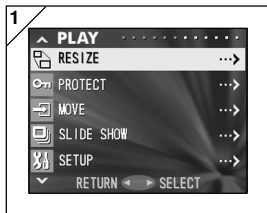

1. Select "RESIZE" and press ►.



2. Select the desired size with ▼ or ▲ and press ► or the MENU/SET button.  
VGA records at 640 × 480 pixels and QVGA at 320 × 240.



3. As you are in the playback mode, press ◀ or ▶ to select an image you want to resize. Then press the MENU/SET button and after the newly resized image is recorded, the display returns to screen 1.
  - If you do not want to resize, select "RETURN" with ▼ or ▲ and press the MENU/SET button.
  - If there is not enough memory to save the image, an error message "MEMORY FULL" is displayed.

# Using the PLAY Menu (Cont'd)

## Setting/Canceling Protection for Your Important Images

- You can protect your important still and moving images from being erased. (You can select some or all images to be protected). You can also cancel the protection.
- If you format a card (p.87), even protected images will be erased.



1. Select "PROTECT" and press ►.

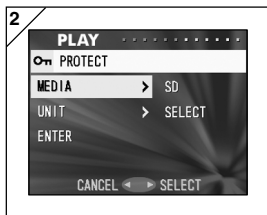

2. A screen with each setting item will appear. At first "MEDIA" is selected, so press ►.
  - To select a different item, press ▼ or ▲.

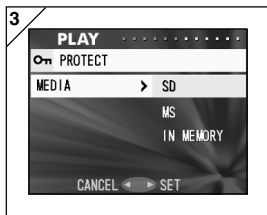

3. Using ▼ or ▲, select the media on which the image to protect (or cancel protect) is recorded, then press ► or the MENU/SET button. The setting is completed and you will return to screen 2.
  - If you press ◀, the setting will be invalidated and you return to screen 2.
  - If there are no images on the media selected, or if a card is not inserted in the camera, you return to screen 3.

## Using the PLAY Menu (Cont'd)

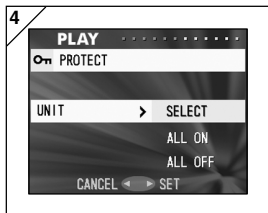

4. Returning to screen 2, select "UNIT". Then the screen shown left (screen 4) appears. After pressing **▶**, if you want to protect (or cancel protect) one or multiple frames, use **▼** or **▲** to choose "SELECT". To protect all frames, choose "ALL ON". Further, to cancel protection of all frames, choose "ALL OFF". After making your selection, press **▶** or the MENU/SET button. The settings are complete and you will return to screen 2.

- If you press **◀**, the settings will be invalidated and you will return to screen 2.

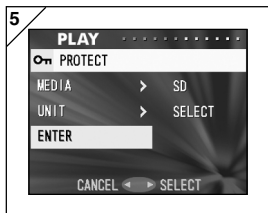

5. After you have made all the settings, select "ENTER" and press either **▶** or the MENU/SET button.

- If you chose "SELECT" for the "UNIT" setting, go to step 6; if you chose "ALL ON" or "ALL OFF", go to Step 8 on page 81.

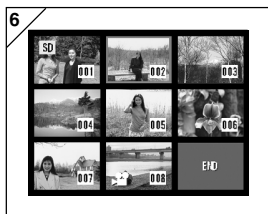

6. The 8-frame index appears. Using **◀**, **▶**, **▲**, or **▼**, move the red frame to an image you wish to protect (or cancel protect) and press the MENU/SET button.

- Pressing **◀** when the first frame is selected or pressing **▶** on the last frame will switch the display to the next eight images.



## Using the PLAY Menu (Cont'd)

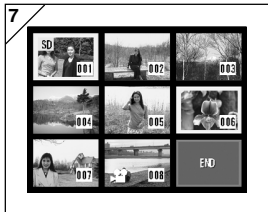

7. Images selected at Step 6 on page 80 are surrounded by a yellow frame. When you have finished selecting images, use ◀, ▶, ▲, or ▼ to select “END”, and then press the MENU/SET button. (Go to Step 8)

To select other images, repeat the selection procedure. (Return to Step 6)

- To select multiple images, repeat the procedures Steps 6 and 7.



8. The confirmation screen appears with “YES” selected.

**If you chose “SELECT” or “ALL ON”:** leave “YES” as is and press the MENU/SET button.

- If you select “NO” with ◀ or ▶ and press the MENU/SET button, your settings will be invalidated and you return to screen 1.



**If you chose “ALL OFF”:** select “YES” with ◀ or ▶ and press the MENU/SET button.

- If you select “NO” and press the MENU/SET button, you will return to screen 1 without canceling any settings.

9. The “Now PROTECT...” (or “Now PROTECT OFF”) screen is displayed. Once settings (or cancel protect) are completed, the display returns to screen 1.

# Using the PLAY Menu (Cont'd)

## Moving the Image Data to Another Memory Card

- You can move previously recorded still or movie image data to another memory card.
- For protected images, you must cancel their protection before you can move them.



1. Select "MOVE" and press ►.

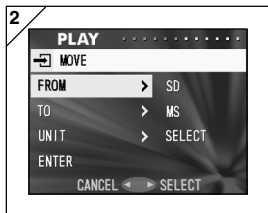

2. A screen with each setting item will appear. At first "FROM" is selected, so press ►.
  - To select a different item, press ▼ or ▲.

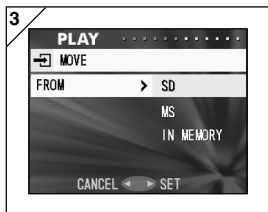

3. Using ▼ or ▲, select the media on which the image you wish to move is recorded, then press ► or the MENU/SET button. The setting is completed and you will return to screen 2.
  - If you press ◀, the setting is invalidated and you return to screen 2.
  - If there are no images on the media selected, or if a card is not inserted in the camera, you return to screen 3.

## Using the PLAY Menu (Cont'd)

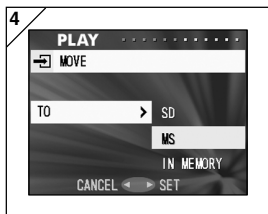

4. Returning to screen 2, select “TO”. Then the screen shown left (screen 4) appears. After pressing ►, use ▼ or ▲ to select the destination media, then press ► or the MENU/SET button.

- If you press ◀, the settings will be invalidated and you return to screen 2.
- If the selected media doesn't have enough free space, or if a card is not inserted, after which you will return to screen 4.

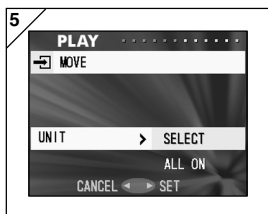

5. Returning to screen 2, select “UNIT”. Then the screen shown left (screen 5) appears. After pressing ►, use ▼ or ▲ to choose “SELECT” (if you are moving one or multiple images), or “ALL” and then press the MENU/SET button.

The settings are complete and you will return to screen 2.

- If you press ◀, the setting is invalidated and you return to screen 2.

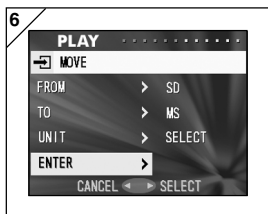

6. After you have made all the settings, select “ENTER” and press either ► or the MENU/SET button.

- If you chose “SELECT” in screen 5, go to Step 7; if you chose “ALL”, go to Step 9.
- If you press ◀, the settings will be invalidated and you return to screen 1.

## Using the PLAY Menu (Cont'd)



7. The 8-frame index appears. Use ◀, ▶, ▲, or ▼ to move the red frame to an image you wish to transfer and then press the MENU/SET button.

- Pressing ◀ when the first frame is selected or ▶ on the last frame will switch the screen to the next eight images.



8. Images selected at Step 7 are surrounded by a yellow frame. When you have finished selecting images, use ◀, ▶, ▲, or ▼ to select “END”, and then press the MENU/SET button. (Go to Step 9)

To select other images, repeat the selection procedure. (Return to Step 7)

- To select multiple images, repeat the procedures Steps 7 and 8.

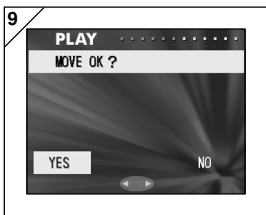

9. A confirmation screen appears. To move the image(s), select “YES” with ◀ or ▶, then press the MENU/SET button.

- If you select “NO” and press the MENU/SET button, you will return to screen 1 without moving anything.

10. The “Now MOVE...” screen is displayed. Once moving is completed, the display returns to screen 1.

# Using the PLAY Menu (Cont'd)

## Playing a Slide Show

- The slide show will proceed in order from the first image at a set interval.



1. Select "SLIDE SHOW" and press ►.
2. Slides will be displayed in order, starting with the 1st slide at about 2 second intervals. The slide show will finish with the last frame displayed.

If you wish to stop during a slide show, press the MENU/SET button.

- If stopped, the current frame will be displayed.

## Selecting the Set-up Menu

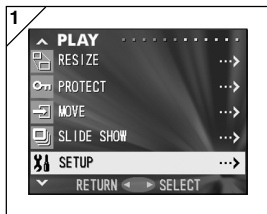

1. Select "SETUP" and press ►.
2. The set-up menu mode screen appears. For details on set-up menu settings, see page 86.

- By setting each item on the set-up menu to your preferences, you can customize your camera to suit you.
  - It does not matter whether the main power is ON or OFF, as the settings are saved by the camera until they are changed.
1. To display the “SET UP” menu screen, select SETUP menu from either the REC menu (p.48) or the PLAY menu (p.85).
  2. Using ▼ or ▲, select the menu settings; every time the button is pressed, the menu scrolls through the items one by one.

↓	FORMAT	↑	(→ p.87)
	REC MENU		(→ p.88)
	QUICK VIEW		(→ p.88)
	INFO DISP		(→ p.89)
	SOUND		(→ p.89)
	DATE SET		(→ p.90)
▼	SELF TIMER	▲	(→ p.90)
	AUTO POWER OFF		(→ p.91)
	NUMBER RESET		(→ p.91)
	MEMORY PRIORITY		(→ p.92)
	LANGUAGES		(→ p.92)
	DEFAULT		(→ p.93)
↓	RETURN		

You can close the set-up menu screen by pressing ◀ or selecting “RETURN” and then pressing the MENU/SET button.

**When you close the set-up menu mode, the LCD monitor will display as follows:**

- 1) If you entered the set-up menu from the REC menu, the display returns to the REC menu.
  - 2) If you entered the set-up menu from the PLAY menu, the display returns to the PLAY menu.
- Refer to the following pages for details on making settings for each menu.

# Using the Set-up Menu (Cont'd)

## Formatting a Memory Card

- Formatting a card returns it to the initial state (when it was purchased).
- Caution: Formatting erases all data, even images that are protected (p.79).
- Always format cards inside the camera. If a card is formatted by a computer it may not perform normally.

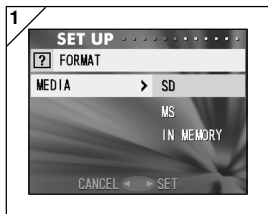

1. Select "FORMAT" and press ►; you will be prompted to select the media type. Use ▼ or ▲ to choose which media type to format and then press either ► or the MENU/SET button.
  - If you press ◀, the setting is invalidated and you return to the set-up menu.

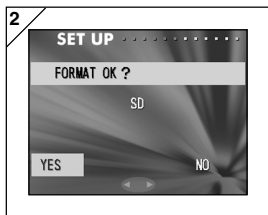

2. You will be asked for confirmation. To execute formatting, select "YES" with ◀ or ► and press the MENU/SET button.
  - If you decide not to format, select "NO" and press the MENU/SET button.

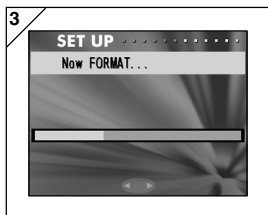

3. Once formatting starts, the message "Now FORMAT..." will appear. When formatting is complete, the camera returns to the set-up menu mode.

 **During formatting be sure not to open the battery/card cover as damage to the card may result.**

# Using the Set-up Menu (Cont'd)

## REC Menu Settings

- You can change the contents of the REC menu from basic (default settings) to advanced.
- See pages 42 and 49 for details on this function.



1. Select "REC MENU", press ► and the settings screen appears. Use ▼ or ▲ to select "DETAILS", and then press either ► or the MENU/SET button. The setting is completed and you return to the set-up menu.
  - If you press ◀, the setting is invalidated and you return to the set-up menu.

## Quick View Settings

- Turn this mode on if you want to be able to check your images on the LCD monitor immediately after you have taken them.
- See page 63 for details on this function.

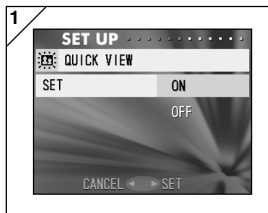

1. Select "QUICK VIEW", press ► and the settings screen appears. Using ▼ or ▲, select "ON" and press either ► or the MENU/SET button. The setting is completed and you return to the set-up menu.
  - If you press ◀, the setting is invalidated and you return to the set-up menu.



# Using the Set-up Menu (Cont'd)

## Make so the Image Information is not displayed

- You can set the camera to not display information (p.36, 60) during shooting or play back.
- The default setting is “ON” (display).

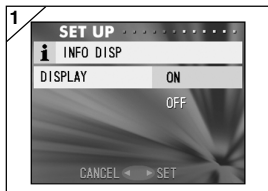

1. Select “INFO DISP” and press ►. Select “OFF” by pressing ▼ or ▲, and press ► or the MENU/SET button. The setting is completed and the screen will return to the set-up menu.
  - If you press ◀, the setting is invalidated and you return to the set-up menu.

## Setting the Operation Sounds

- You can turn on and off the beeps (sounds made for each type of operation and warnings).
- The default setting is turned “ON” (set to sound).

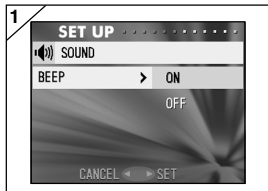

1. Select “SOUND”, press ► and the settings screen appears. Using ▼ or ▲, select “OFF” or “ON” and press either ► or the MENU/SET button. The setting is completed and you return to the set-up menu.
  - If you press ◀, the setting is invalidated and you return to the set-up menu.

# Using the Set-up Menu (Cont'd)

## Adjusting the Date and Time

- If the battery is removed for approximately 24 hours or more, the date and time settings will be lost. In this case, please reset the date and time.

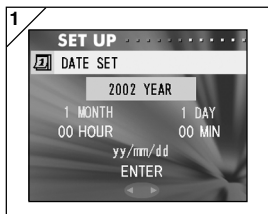

1. Select "DATE SET", press ► and the date and time settings screen appears. See Steps 3 to 7 on pages 24 and 25 about how to make the settings.
  - Once settings are completed, you will return to the set-up menu.

## Setting the Self-timer Delay Time

- You can change the length of time the self-timer delays before shooting from 10 seconds (default) to 3 seconds.



1. Select "SELF TIMER", press ► and the settings screen appears. Using ▼ or ▲, select "3 sec" and press either ► or the MENU/SET button. The setting is completed and you return to the set-up menu.
  - If you press ◀, the setting is invalidated and you return to the set-up menu.

# Using the Set-up Menu (Cont'd)

## Setting the Auto Power-OFF Time

- You can change the Auto Power-OFF not-in-use interval starting at 3 minutes (default).

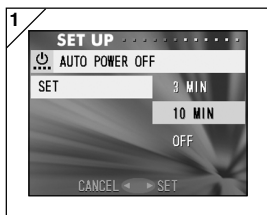

1. Select "AUTO POWER OFF", press ► and the settings screen appears. Use ▼ or ▲ to select "10 min" or "OFF" and then press either ► or the MENU/SET button. The setting is completed and you return to the Set-up menu.
  - If you press ◀, the setting is invalidated and you return to the set-up menu.

## Resetting the File Numbers

- You can reset your file numbers.

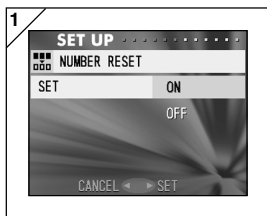

1. Select "NUMBER RESET", press ► and the settings screen appears. Using ▼ or ▲, select "ON" and press either ► or the MENU/SET button. The setting is completed.
  - If you press ◀, the setting is invalidated and you return to the set-up menu.

### Reference:

- At initial setting, "NUMBER RESET" is turned "OFF", and it will assign consecutive file numbers as follows.  
XXXXX1.jpg, XXXXX2.jpg, XXXXX3.jpg...
- If there are no images shot on the card when "NUMBER RESET" is turned "ON", it will attach numbers starting with XXXXX1.jpg. If pictures exist, the number following already existing file numbers will be given.

# Using the Set-up Menu (Cont'd)

## Setting Memory Priority

- When you have 2 cards in the camera at once, an SD memory card (or Multi-Media card) and a Memory Stick, you can decide which to record to first.

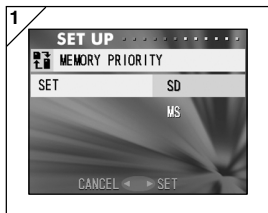

1. Select "MEMORY PRIORITY", press ► and the settings screen appears.  
Using ▼ or ▲, select the media type to have priority and press either ► or the MENU/SET button. The setting is completed and you will return to the set-up menu.
  - If you press ◀, the setting is invalidated and you return to the set-up menu.

## Changing Languages

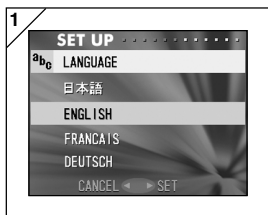

1. Select "LANGUAGE", press ► and the language settings screen appears.  
See page 24 for instructions on making the settings.
  - When the setting is completed, you will return to the set-up menu. If you press ◀, the setting is invalidated and you return to the set-up menu.

# Using the Set-up Menu (Cont'd)

## Restoring the Default Settings

- You can change the various settings made in the set-up menu back to their default settings all at one time.

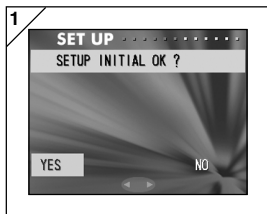

1. Select "DEFAULT", press ► and a confirmation screen will appear. Using ◀ or ►, select "YES" and press the MENU/SET button.

The setting is completed and you return to the set-up menu.

- If you select "NO" and press the MENU/SET button, the setting is invalidated and you return to the set-up menu.

**Operating Environments**

- Images recorded with the camera can be transferred to a PC using the USB cable supplied.

**1. Windows**

OS: Preinstalled versions of Microsoft Windows 98, Windows 98SE, Windows XP, Windows 2000 Professional or Windows Me

Memory: 16MB or more of available RAM (32MB or more recommended)

Display: 32,000 colors or more, resolution of 640 × 480 pixels or more

Others: CD-ROM drive, USB port (standard equipped)

**2. Macintosh**

OS: Mac OS 9.0/9.1/9.2/Mac OS X (Version 10.0.4-10.1)

CPU: PowerPC or more

Memory: 16MB or more of available RAM (32MB or more recommended)

Display: 32,000 colors or more, resolution of 640 × 480 pixels or higher

Others: CD-ROM drive, USB port (standard equipped)

## Connecting to your PC (Cont'd)

### Connecting with a USB cable

- Turn OFF the power supply to the camera.
- There is no need to turn off your PC power supply when connecting or disconnecting the USB cable to the camera.

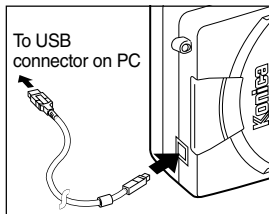

1. Turn on the power supply to your PC, and start up the Windows or Mac OS.
2. When Mac OS or Windows desktop screen appears, connect the camera and PC using the USB cable.

- Please use only the USB cable supplied with the camera.
- While the camera is connected to your PC, the camera is inoperable.
- While connected to your PC, do not detach the USB cable or open the battery/card cover.
- Turn the power supply to the camera OFF when detaching the USB cable.
- When communicating with your PC, we recommend using the AC adapter (sold separately). Attach/detach the AC adapter when the camera power supply is OFF and your PC and the camera are not connected.

### Downloading (transferring) Images

- To conserve the battery, using the AC adapter (sold separately, model no.: DR-AC4) is recommended.
  - If you are using Windows 98 or Windows 98SE, first install the "USB device driver software" (attached CD-ROM) (pp.98-99).
1. Turn on the power supply to your PC, and start up Windows or Mac OS, and connect your camera and PC with USB cable (p.95).
  2. If you are using Windows, open "My Computer" and double-click the newly created icon "removable device". If you are using Mac, a "Undefined Name" icon will be displayed on the desktop.
  3. Double-click the "DCIM" folder.
  4. If you double-click "100 KONIC", the image file icon will be displayed.
    - The first 3-digit number of "100 KONIC" differs depending on the directory in the card.
  5. If you double-click the file, the image will be displayed. When saving the file, copy it to where you want to save it.



### **Notes**

- The camera cannot be connected to your PC if no image data is recorded on the built-in memory of the camera, or a card with an image data record is not in the camera.
- Image files can be copied to a hard disk or other media and deleted as necessary. For details, refer to the instruction manual operating system in use.  
Please note that Konica will not be responsible for any loss resulting from such operations.
- Always back up important data.
- The protect setting set with this camera is equivalent to the read-only attribute of a file.  
Please note that, if the attribute of a file is changed using a PC the protect setting set with the camera will be disabled.
- Do not change the file name of image data saved on an SD Memory Card/Multi-Media Card/Memory Stick using a PC or save files other than image data taken by this camera. Images that have been altered or newly saved on an SD Memory Card/Multi-Media Card/Memory Stick using a device other than this camera will not only play back on the camera but may cause the camera to malfunction when inserted.
- Do not format the SD Memory Card or Multi-Media Card or Memory Stick using a PC. Data may become damaged.

# Installing software from the CD-ROM supplied

## Installing USB Driver Software

- Install the software only if you are using Windows 98 or Windows 98SE. If you are using another OS, you do not need to install this.
- Turn OFF the power supply to the camera.
- To conserve the battery, using the AC adapter (sold separately, model no.: DR-AC4) is recommended.

- 1) Turn on the PC power and start Windows.
- 2) After connecting your camera and PC with USB cable (p.96), turn ON the power supply to the camera.
- 3) The “Add New Hardware Wizard” screen will appear.



- 4) Insert the CD-ROM supplied into the CD-ROM drive.
- 5) Click “Search for the best driver for your device (Recommended).” and then click “Next”.



# Installing software from the CD-ROM supplied (Cont'd)

- 6) Click “Specify a location:” and input “D:\”.  
Click “Next”.



- Here, the CD-ROM drive is assumed to be drive D.  
Use a different letter if appropriate.
- The INF file necessary for the install is located in “D:\”.
- When searching a different location, click “Browse”.

- 7) Click “Next”.



- 8) Click “Finish”.  
The USB device driver is now installed.



## Using Windows

### Installing the included software (CD-ROM) and KD-310Z User's Guide



- 1) Turn on the PC power and start Windows.
- 2) Set the included CD-ROM in the CD-ROM drive.
- 3) Click the Start button and select "Run..."

4) Enter "D:\install.exe" and click "OK".



- The above assumes that your CD-ROM is D. To check the CD-ROM drive letter of your PC, open "My Computer" and check the letter displayed on the CD-ROM drive icon.

## Installing software from the CD-ROM supplied (Cont'd)

- 5) Check to see that “QuickTime”, “Adobe Acrobat Reader” and “KD-310Z User’s Guide” in the “KONICA KD-310Z setup menu” are checked and click “OK”.
- Be sure to install “QuickTime”, “Adobe Acrobat Reader” and “KD-310Z User’s Guide”.



- 6) Software checked in 5) will be installed in order. Follow the onscreen guidance to continue the installation.

Note: Clicking “Cancel” during the installation process will cancel installation. In this case, perform the installation again.

However, do not restart the PC until all the installations have been completed.

- 7) When all of the software checked in 5) have been installed, the “KD-310Z Setup Menu” screen will appear. Click “OK” to finish the installation process.

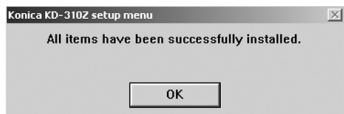

### Viewing the KD-310Z User’s Guide

- 1) Double click the “KD-310Z User’s Guide” icon on the desktop.
- 2) The KD-310Z User’s Guide will be displayed.

## Using Macintosh

### Installing the Adobe Acrobat Reader

QuickTime installation is not necessary.

- Be sure to install if Adobe Acrobat Reader is not already installed in your PC. And it is not necessary to install the Adobe Acrobat Reader for Mac OS X users.

1) Turn on the power of your PC, and set the included CD-ROM in the CD-ROM drive.

2)  Double click the "Konica" icon.

Konica

3)  Double click the "Adobe" icon.

Adobe

4)  Double click the "English" icon.

English

5)  Double click the "Acrobat Reader Installer" icon.

Acrobat Reader Installer

6) Follow the instructions shown on the screen.

### Installing the KD-310Z User's Guide

- Be sure to install.

1) Set the included CD-ROM in the CD-ROM drive.

2)  Double click the "Konica" icon.

Konica

3)  Double click the "Manual" folder.

Manual

4)  Copy "GUIDE\_EN" to a location of your choice.

GUIDE\_EN

5) Double click the copied "GUIDE\_EN" to display the "KD-310Z User's Guide".

## When Carrying the Camera Overseas

### **Using the dedicated AC adapter kit (Model No.: DR-AC4)**

- Please do not use the AC adapter where the voltage is outside the displayed power supply voltage (AC 100V to AC240V).

### **Using the Attached Charger (Model No.: DR-BC-K4)**

- Please do not use the charger where the voltage is outside the displayed power supply voltage (AC 100V to AC240V).

## Cleaning the camera

**When cleaning the camera, do not use solvents such as benzene or paint thinner.**

- Before cleaning, remove the batteries from the camera, or disconnect the power plug of the AC adapter from the wall outlet.
- The exterior casing surface consists of paint and printing. Wiping the casing with benzene or paint thinner may cause discoloration, or the paint or printing to be removed.
- When the camera becomes dirty, wipe off the dust with a soft, dry cloth. For stubborn dirt, dampen a cloth in diluted neutral detergent (kitchen detergent), wring thoroughly and wipe. When finished, wipe the camera with a dry cloth.
- When using a chemical cloth, follow the safety precautions of the product.

## After using the camera

**If the camera is not to be used for a long period, remove the batteries and ensure that the power plug of the AC adapter is disconnected from the wall outlet.**

- Leaving the batteries inside the camera for a long time may cause the battery fluid to leak, resulting in malfunction of the unit.
- When storing, keep both camera and batteries in cool place with low humidity and under constant temperature as much as possible.  
Recommended temperature: 15° – 25°C (59° – 77°F)  
Recommended humidity: 40% – 60%

## About the SD Memory Card/Multi-Media Card/Memory Stick

### Handling

- Do not bend or apply excessive force.
- Do not store the card in places with high humidity, dusty places or where static electricity or electromagnetic fields are likely to occur.
- Keep dust, water and foreign objects away from the terminal section.



### About image data

- Use a PC to delete images and files recorded with other models.
- The recorded data may be lost when you or a third part misuses the SD Memory Card/Multi-Media Card/Memory Stick, if the card is affected by strong static electricity or electrical shock, or during card repair or malfunction.  
Konica will not be responsible in any way for the loss of recorded data or the consequences of such loss.

### About the LCD monitor

- The LCD monitor has been developed using high-precision engineering. Although the percentage of active pixels is more than 99.98%, there may be missing or constantly lit pixels.
- When using the LCD monitor in a cold location, the screen may appear darker than normal immediately after starting use. The screen will return to normal brightness as the internal temperature of the camera rises.
- When the LCD monitor becomes dirty with finger prints or dust, wipe with a soft, dry cloth.

# Troubleshooting

- If the following does not solve your problem, please contact the point of purchase.

	<b>Symptom</b>	<b>Check this:</b>	<b>Page</b>
<b>Power Supply</b>	Power will not turn ON	<ul style="list-style-type: none"> <li>• Battery level too low</li> <li>• Battery inserted incorrectly</li> <li>• AC Adaptor attached incorrectly</li> </ul>	19 19 22
	Power turns OFF right after turning on	<ul style="list-style-type: none"> <li>• Battery level too low</li> <li>• Low ambient temperature</li> </ul>	19 109
<b>Shooting the pictures</b>	Can't take a picture even if pressing the shutter button	• Power supply not on.	23
		• SD Memory Card or Memory Stick's write protected.	13
		• Pictures taken have reached the maximum number. → Erase unwanted pictures.	64,70
		• Set to the Self-Timer mode.	41
	Can't focus	• Flash being charged.	39
		• Subject not in the center	34
• Subject hard to focus		34	
LCD monitor display and images are not clear	• Dirty lens	31	
	• Incorrect distance from the subject	32	
Doesn't Flash	• LCD brightness adjusted incorrectly	47,73	
	• Finger prints or dirt on the monitor	105	
	• Set to "Flash off" mode	40	

## Troubleshooting (Cont'd)

	<b>Symptom</b>	<b>Check this:</b>	<b>Page</b>
<b>Play back</b>	Won't play back	• PLAY button not ON	59
		• No image data	59
		• All image data is erased	64,70,87
	Image with no natural color	• White balance incorrect	54
Image appears dark	• Distance too great, the flash didn't reach the subject • Not enough light	39	
		33	
Image too bright	• Flash used with subject too close	39	
<b>Other</b>	Can't transfer to your PC	• Not connected to your PC correctly	95
		• No image data inserted in the camera	97
	Incorrect date and time	• Left without battery over 24 hours	90

# Main Specifications

Model	: Digital Still Camera with zoom lens
Effective picture resolution	: 3.2 mega pixels
Recording media	: Internal recording media; approx. 2MB flash memory built-in External recording media; SD Memory Card, Multi Media Card, Memory Stick
Image recording capacity	: 2048 × 1536 pixels (About 98 frames/SD Memory Card at 64MB) 1600 × 1200 pixels (About 213 frames/SD Memory Card at 64 MB) 640 × 480 pixels (About 640 frames/SD Memory Card at 64 MB)
Recording method	: Still picture; JPEG (DCF compatible <sup>1)</sup> ) / DPOF compatible <sup>2)</sup> Movie; DCF Compatible (AVI style Motion JPEG compatible)
Image pickup	: 1/1.8 inch CCD Total resolution 2140 × 1560 pixels (approx. 3,340,000 pixels)
Lens	: F 2.8-4.9, f=8-24mm (7 frame in 6 group) Equivalent to 35mm camera conversion of 39 to 117mm
Focus adjustment/Photometric	: TTL center-weighted metering using a CCD image surface luminance signal, spot metering
Focal Range	: Normal; wide angle 0.5m to ∞ (1.6" to ∞), telephoto 0.8m to ∞ (2.6" to ∞) Macro mode Macro-photo; wide angle 0.1m to ∞infinity, telephoto 0.5m to ∞infinity
Aperture	: Wide angle; F2.8/F4.7, Telephoto; F4.9/F8.2
Shutter speed	: Still picture; about 1 to 1/2000sec. Movie; about 1/30 to 1/5000sec
Exposure control	: Program AE (3EV-15.5EV)
White balance	: Auto correct, manual setting (daylight, overcast, tungsten, fluorescent)
Viewfinder	: True-image zoom viewfinder
Flash	: Built-in auto adjust lighting flash, flash interval about 5 sec. Flash working range; wide angle about 0.5m to 3.5m (1.6" – 9.9") telephoto about 0.5m to 2.0m (1.6" – 6.6") Viewfinder red LED on while charging

## Main Specifications (Cont'd)

Shooting modes	: Single shooting/ red eye reduction/ forced flash/ portrait night view/ no flash/ macro-photo/ distant view/ self-timer (10 sec, 3 sec.)/ digital zoom (x2)/ movie (320 × 240, with maximum length of 15 sec.) / sepia
LCD monitor	: 1.5 inch low temperature poly-silicon TFT with back light LCD color monitor
Playback	: Single frame/ index playback/ slide show playback/ digital zoom playback
Erase function	: Single frame/ designated frames/ all frames/ format
LED display	: Self-timer LED, viewfinder LED
Buzzer	: When shooting, as a warning
Auto-date function	: Year, month, date and time up to 2050 <sup>3)</sup>
Power supply	: Lithium battery, dedicated AC adapter (sold separately)
I/O terminals	: USB terminal
Operating temperature	: 0° (32°)-50°C (122°F) (humidity 20%-80%)
Dimensions	: 94(W) × 56(H) × 29.5 (D)mm (3 <sup>3</sup> / <sub>4</sub> "(W) × 2 <sup>1</sup> / <sub>4</sub> "(H) × 1 <sup>3</sup> / <sub>16</sub> "(D)) (except parts that stick out)
Weight	: 198 g (65oz) excluding battery, card
Attachments	: Lithium-ion battery, charger/power supply cord, USB cable, CD-ROM, strap, warranty card, SD Memory Card, Quick guide

- The performance of the items above is according to the conditions used in our test.
- The specifications and/or appearance of the product may be altered without notification.

<sup>1)</sup> DCF (Design rule for Camera File system) is a standard by JEITA mainly for the purpose of simplifying the use of image files taken by digital cameras with other related devices.

<sup>2)</sup> DPOF (Digital Print Order Format) specified by Canon, Inc., Kodak Co., Ltd., Fuji Photo Film Co., Ltd., and Matsushita Electric Industrial Co., Ltd. is a standard for recording specified information such as the images or quantity to print from the images taken by a digital camera on a recording medium.

<sup>3)</sup> Manganese lithium silicon batteries are in use as back-up batteries for calendar system (Refer to p.25). It is recommended to replace with new ones at least once three to five years. (Additional charge is required at the time of replacement.)

# Warranty and After-sales Service

**For repair, handling and care, first consult the dealer from whom you purchased the camera.**

## **Warranty (separately attached)**

Before accepting the warranty card, please make sure that the date of purchase and dealer of purchase and the dealer's details have been completed. After reading the warranty, keep it in a safe place.

**Warranty period (main unit): one year from the date of purchase**

## **When requesting service**

If symptoms persist after having checked the table on pages 106 and 107, Troubleshooting, disconnect the power supply and contact the dealer from whom you purchased the camera.

**Note: Transportation cost for taking/bringing back the product to/from repair, shipping costs or carrying charges are at the customer's expense. When shipping the product, pack the unit appropriately and use a shipping method such as registered mail or express mail to prevent loss of the product.**

## **During the warranty period**

Repairs will be made by the dealer from whom you purchased the camera according to the contents of the warranty. For repair, take the product and the warranty to the dealer from whom you purchased the camera.

## **Outside the warranty period**

Repairable products can be repaired for a charge upon request. However, the minimum holding period of performance parts for repairing digital still cameras is 8 years after termination of production.

**Note: Performance parts for repair are parts necessary to maintain the functions of the product.**

## **FCC Compliance Statement:**

Declaration of Conformity

Responsible party: KONICA PHOTO IMAGING

Address: 725 Darlington Avenue Mahwah, NJ 07430, U.S.A.

Telephone number: (201) 574-4000

This device complies with Part 15 of the FCC Rules. Operation is subject to the following two conditions:

- (1) this device may not cause harmful interference and (2) this device must accept any interference received, including interference that may cause undesired operation.

This equipment has been tested and found to comply with the limits for a class B digital device, pursuant to Part 15 of the FCC Rules. These limits are designed to provide reasonable protection against harmful interference in a residential installation. This equipment generates, uses and can radiate radio frequency energy and, if not installed and used in accordance with the instructions, may cause harmful interference to radio communications. However, there is no guarantee that interference will not occur in a particular installation. If this equipment does cause harmful interference to radio or television reception, which can be determined by turning the equipment off and on, the user is encouraged to try to correct the interference by one or more of the following measures:

- Reorient or relocate the receiving antenna.
- Increase the separation between the equipment and receiver.
- Connect the equipment into an outlet on a circuit different from that to which the receiver is connected.
- Consult the dealer or an experienced radio/TV technician for help.
- Shielded cables must be used for this equipment to comply with the relevant FCC regulation.
- Power requirement is DC 4.2V  $\pm$  10% and 1.5 A max. Use only listed certified power supply adapter.
- The user is cautioned that changes and modifications made to the equipment without approval of the manufacturer could void the user's authority to operate this equipment.

 Tested To Comply  
With FCC Standards  
FOR HOME OR OFFICE USE

- However, note that operation of this unit near a radio or television receiver could possibly cause radio disturbance.

## **CANADA ONLY**

Industry Canada's Compliance Statement:

This Class B digital apparatus complies with Canadian ICES-003.

Cet appareil numérique de la classe B est conforme à la norme NMB-003  
du Canada



**Konica**