

# Konica

## Digital Still Camera

# Digital Revio

## KD-200Z

### User's Guide

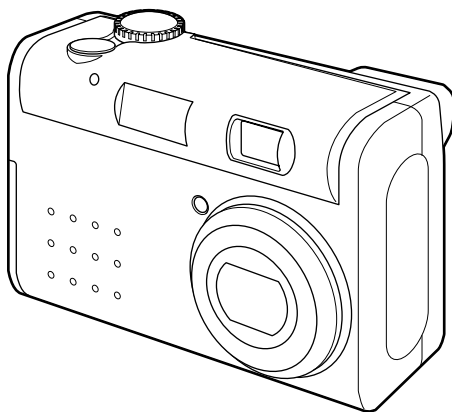
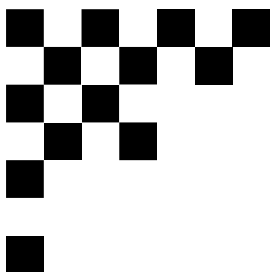

Thank you for your purchase. For the correct usage of this product, please read this User's Manual and the warranty card carefully and keep them in a safe place for future reference.

Before accepting the warranty card, please make sure that the date of purchase and the dealer's details have been completed.

### **About trademarks**

- Windows 98, Windows 98SE, Windows 2000 Professional and Windows Me are trademarks or registered trademarks of Microsoft Corporation in the U.S. and other countries.
- Apple, Macintosh, Mac OS, QuickTime and Power PC are trademarks or registered trademarks of Apple Computer in the U.S. and other countries.
- The SD logo is a trademark.
- Other company names and product names are trademarks or registered trademarks of their respective owners.

### **About voluntary restriction concerning radio wave interference**

This equipment is a class B information technology device based on the standards of VCCI (Voluntary Control Council for Interference). Use of this device near radios and television tuners may cause reception interference. Please use this product correctly according to the contents of this User's Manual.

Machine Noise Information Ordinance 3. GSGV, January 18, 1991:

The sound pressure level at the operator position is equal or less than 70 dB(A) according to ISO 7779.

Note: This User's Guide uses illustrations to explain button operations. Please note, however, that the button layout may differ slightly from the actual product.









# Contents

● Important Safety Precautions .....	5
● Before Using .....	11

## Chapter 1 Preparation

.....	
Checking package contents .....	12
Names of parts .....	13
Installing the Battery/AC Adapter (Optional) .....	16
Inserting/Removing the SD Memory Card/Multi-Media Card ...	18
Installing the Strap .....	19
Adjusting the Menu Display Language and Time/Date .....	20

## Chapter 2 Basic Recording ( /REC)

.....	
Recording .....	22
Setting the Picture Quality .....	28
Selecting the Recording Mode .....	29
 (Auto) Mode .....	30
 (Red-eye Reduction) Mode .....	30
 (Forced Flash) Mode .....	30
 (Night View Portrait) Mode .....	31
 (Flash Off) Mode .....	31
 (Long Distance) Mode .....	31
 (Macro Recording) Mode .....	32
 (Self-timer) Mode .....	34
Adjusting the Screen Contrast .....	35

## Chapter 3 Advanced Recording ( /M-REC)

.....	
Using the M-REC menu .....	36
Recording a Movie .....	38
Using the Digital Zoom .....	39
Exposure Compensation .....	40
Changing the White Balance .....	41
Changing the AE mode .....	42
Changing to Slow Shutter Speed .....	42
Adjusting the Screen Contrast .....	43
Recording in Black and White .....	44
Resetting the Camera to Default Settings .....	45

## Chapter 4

## Basic Playback (▶/PLAY)

Playing Back Images .....	46
Playing Back Movies .....	48

## Chapter 5

## Advanced Playback/Erasing (▶/PLAY)

Using the PLAY Menu .....	49
Erasing Images .....	50
Viewing Multiple Images (Index Playback) .....	52
Viewing a Slideshow of Images .....	53
Keeping Important Images (Protect Setting) .....	54
Displaying the file number .....	56
Adjusting the Screen Contrast .....	56
Selecting the Image to Print (DPOF) .....	57

## Chapter 6

## Advanced Operations (SET/SET UP)

Using the SET-UP Menu .....	62
Customizing the Camera .....	63

## Chapter 7

## Installing the Software and Transferring Images to a PC

Operating Environments .....	67
Using Windows .....	67
Using Macintosh .....	71

## Chapter 8

## Appendix

When Carrying the Camera Overseas .....	73
Caring and storage .....	73
Troubleshooting .....	75
Main specifications .....	77
Warranty and After-sales Service .....	78

# Important Safety Precautions

This product has been designed with safety in mind; however, please read the following display marks, warnings and cautions for its correct usage.

The following warning and caution symbols are to prevent damage to the user, other persons and property.

## Definitions of the symbols

The following categories explain the degree of danger or damage that may occur if the displayed content is not followed or the product is misused.



### **Warning**

This symbol indicates that misuse may result in serious injury and even death.

---



### **Caution**

This symbol indicates that misuse may result in bodily injury or physical damage.

The following categories explain the contents to be followed using symbols.



This symbol indicates that the content requires caution when performed.



This symbol indicates that the content is prohibited.



This symbol indicates that the content must always be followed.

# Important Safety Precautions

## **Warning**



Should any of the following occur, stop using the product immediately. Remove the batteries from the unit and disconnect the AC adapter. If using the AC adapter, disconnect the power plug from the wall outlet.

Consult the dealer from whom you bought the product for further assistance.

Continued use of the product may result in fire or electrical shock.

- **If you notice any abnormality such as smoke or an abnormal smell, or if the camera becomes extremely hot.**
- **If liquid gets inside the camera.**
- **If any foreign object gets inside the camera.**



**Do not dismantle, modify or repair the camera yourself.**

Fire and/or electrical shock may occur as a result.

For repair or internal inspection, consult the dealer from whom you bought the product.



**Do not allow the camera to get wet.**

Fire, electrical shock and/or malfunction of the unit may occur if internal parts are exposed to water or other liquids.



**Do not drop or insert metal objects or combustible items inside the camera.**

Fire, electrical shock and/or malfunction of the unit may occur as a result when metal objects, etc. getting inside the camera.



**Do not use the camera while driving.**

May cause traffic accidents.

When using the camera while walking, pay attention to the road surface, surroundings, etc.



**Do not use the camera on unstable ground.**

Serious injury and even death may occur as a result especially when falling from high places.



**Do not directly look at the sun through the viewfinder.**

Loss of or impaired eyesight may result.



**Do not touch the metal parts on the camera during thunder and lighting.**

Death may occur if lightning strikes the camera.

# Important Safety Precautions

## **Warning**



**Do not use AC adapters other than those specified.**

Fire may occur as a result of AC adapters other than those specified being used.



**Do not dismantle, short-circuit, coat (solder, etc.), apply heat, apply pressure (with nail, etc.) to the battery, or throw into a fire. Furthermore, do not allow metals (wires, necklaces, etc.) to come into contact with batteries.**

Fluid leakage, heat, fire and damage may occur as a result.

## **Caution**



**Do not point the lens directly at the sun or at a strong light source.**

Malfunction of internal parts may occur from concentrated rays of light. Using the camera in such conditions may cause short circuits and breakdown of insulation, resulting in overheating and/or fire.



**Take care not to get fingers caught in the battery/card cover.**

Personal injury may occur as a result.



**When using the camera inside an airplane, follow the directions of the airline company.**

Electric waves emitted from the camera may affect airplane cockpit instruments.



**Do not leave the camera in locations such as:**

- **A location exposed to direct sunlight or inside a car, etc. where the temperature may become extremely high.**

Fire and/or damage to the unit may occur.

- **Within the reach of children.**

The strap may wrap around the neck causing strangulation, or accessories such as batteries, SD Memory Card, etc. may be swallowed.

- **Unstable surfaces such as on an unstable table or an angled surface.**

Camera dropping on the head or other body parts may not only cause personal injury but malfunction of the unit as well.

- **A location exposed to lampblack, steam, high humidity, dust or vibration.**

If dust or liquid enters the camera or if the internal parts are damaged by strong vibration, overheating, fire or electrical shock may occur as a result.

# Important Safety Precautions

## **Caution**



**Do not use force when operating the camera.**

The camera may become damaged, causing personal injury as a result.



**Do not use the flash near eyes.**

Eye injury may occur as a result.



**Check that the polarity is correct when inserting batteries.**

The battery may heat, damage or leak if the polarity is not correct, possibly causing skin burns and/or personal injury as a result.



**Do not use batteries which have become soiled with oil or sweat.**

If soiled, wipe the contacts with a dry cloth before use.



**When cleaning or carrying out non-photographic operations on the camera, disconnect the AC adapter for safety.**



**Remove the batteries when the camera will not be used for an extended period.**



**If the camera is to be used by a child, the correct usage must be taught by a parent or guardian.**

Personal injury may occur as a result.



**Do not rotate the camera when mounting on a tripod.**

### **About battery fluid leakage**

- Should battery fluid leaks ever come into contact with hands or clothing, wash immediately with water.
- Loss of eyesight may occur if battery fluid enters the eye. In such case, do not rub the eye. Immediately flush the eye with water and seek medical attention.



## About the LCD monitor

- Due to the characteristics of liquid crystals, the brightness of the LCD monitor may appear uneven with changes in temperature, etc.
- The LCD monitor has been developed using high-precision engineering and is superior in sharpness and picture quality. Due to the nature of liquid crystals, however, there may be missing or constantly lit pixels on the monitor. This is not a malfunction of the unit.
- If the LCD monitor becomes damaged for some reason, take care to prevent personal injury from broken glass, etc. Furthermore, take care that liquid crystals do not touch the skin or enter the eyes or mouth.

## About the SD Memory Card/Multi-Media Card

As well as the SD Memory Card included with this camera, Multi-Media Cards may also be used.

### **Caution**

SD Memory Cards and Multi-Media Cards are manufactured using precision electronic components. Do not perform the following as malfunction or damage may occur as a result.

- Do not touch the terminal with hands or metal objects. Damage to the components may occur as a result of static electricity. Before handling an SD Memory Card or Multi-Media Card, discharge any static build-up from your body by touching grounded metal, etc.
- Do not bend, drop or apply excessive force.
- Avoid heat, liquid and direct sunlight when using and for storage.
- Do not open the battery/card cover or remove the SD Memory Card/Multi-Media Card while data is being read or written.
- Do not dismantle or modify.



## Important

- When using Multi-Media Cards, the operation response time may be longer during shooting and playback when compared with the SD Memory Cards. However, this is due to the specification of the Multi-Media Card and is not a malfunction.
- The SD Memory Card includes a write-protect switch. Sliding this switch downward prevents data from being written to the card and images, etc. saved on the card are protected. Please note that pictures cannot be taken or deleted when the write-protect switch is on. If such an operation is attempted, you will be notified by an LED lighting in the viewfinder and a buzzer sound-ing. (See page 22.)
- When using a large-capacity card, card check and deletion may take some time.
- Always back-up important data.
- When using SD Memory Cards/Multi-Media Cards on a PC, do not change the attributes (read-only, etc.) of the files (image data) on the card. Doing so may prevent the camera from working properly when deleting images, etc.
- Do not change the file names or the directory name of image data saved on an SD Memory Card/Multi-Media Card using a PC or save files other than image data taken by this camera. Images that have been changed or added will not only play back on the camera but may cause the camera to malfunction as well.
- Always format SD Memory Cards/Multi-Media Cards using this camera. A card formatted in a PC may not operate properly.
- Data loss may occur at times due to malfunction or damage. However, Konica will not be responsible in any way in the event of such data loss.

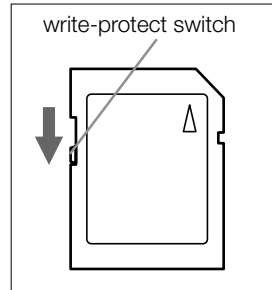

# Before Using

## ● Perform test shooting

Always take some test shots before taking important pictures such as weddings, etc. to make sure that the camera is working properly.

## ● Shot contents are not guaranteed

No compensation will be made for pictures that are unsuccessful due to problems with the camera or SD Memory Card/Multi-Media Card.

## ● Be aware of copyright

Images that you shoot are for personal use only. Using pictures without the permission of the rightful owner is prohibited by copyright law. Furthermore, there may be places where shooting is restricted even for the purpose of personal enjoyment.

## Camera power supply

### 1. Batteries (available at camera stores, etc)

- CR-V3 lithium battery (1 unit/supplied)
- Rechargeable AA nickel-hydrogen battery (2 units/optional)
- AA alkaline battery (2 units/optional)

**Notes:** ● Do not mix AA lithium batteries and manganese batteries. Use the prescribed battery.

- When using rechargeable batteries, read the instruction manual of the batteries and charger before use.
- It is a characteristic of rechargeable batteries that they may not be sufficiently charged when used for the first time.
- Rechargeable batteries cannot be charged in the camera.
- The number of pictures that can be taken varies according to the performance and usage conditions of the batteries.
- When discard the used battery, dispose it in accordance with the regulation in the concerned area.
- Don't use or leave the battery at a high temperature place such as a strong sunshine, a car inside under hot weather, and a front of a stove.

### 2. Household power outlet

- Use AC adapter (optional/model: DR-AC2).

# Chapter 1 Preparation

## Checking package contents

### Accessories



Quick Guide



Konica Card

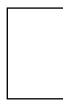

Warranty Card

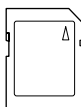

SD Memory Card 8MB (1 unit)

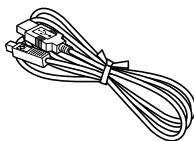

USB cable

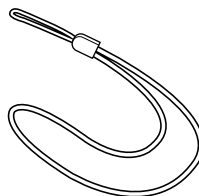

Strap

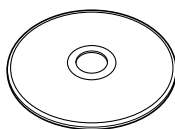

CD-ROM

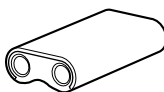

CR-V3 lithium battery (1 unit)

- Driver software (Windows 98/98SE)
- QuickTime (Windows)
- Adobe Acrobat Reader (Windows/Macintosh)
- KD-200Z User's Guide (Windows/Macintosh)

### Optional accessories

- AC adapter (model: DR-AC2)
- Soft case (model: DR-CC1)

# Names of parts

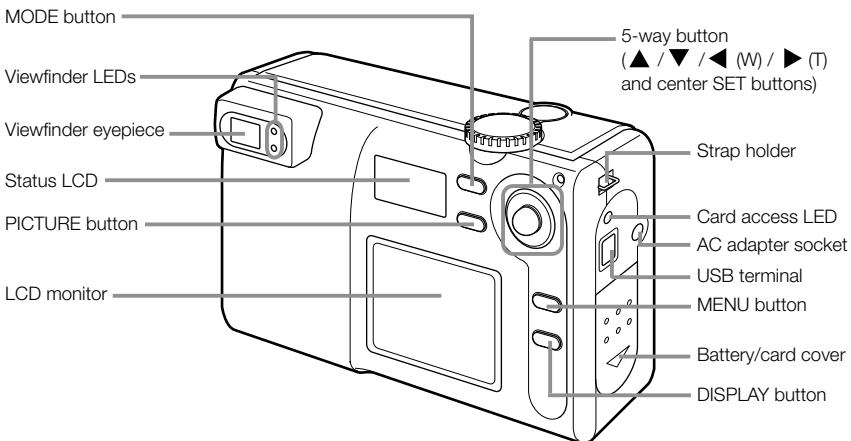
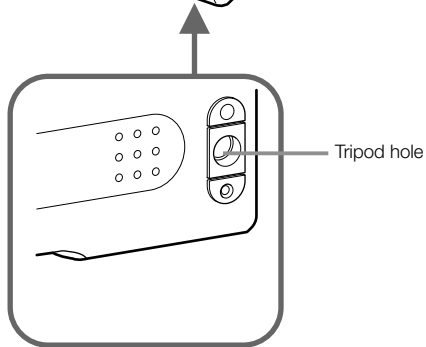
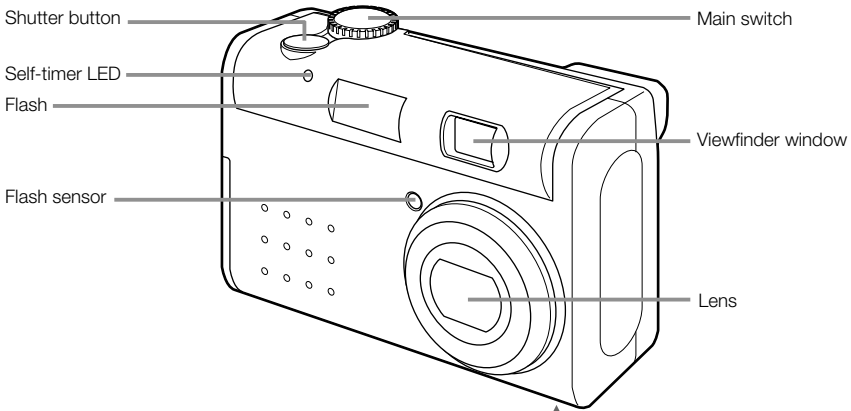

## Main switch

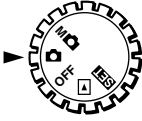

### **Manual mode (M-REC)**

Images can be recorded using manual settings.

### **Auto mode (REC)**

Images can be recorded using default settings.

### **OFF** **Power off**

The camera is turned off.

### **Playback mode (PLAY)**

Images recorded can be played back on the LCD monitor.

### **SET** **Setup mode (SET UP)**

Various settings can be changed.

#### Note:

\* For details on default settings, see "Default settings are" of page 45. The camera mode and picture quality mode can also be selected (see page 15).

## 5-way button

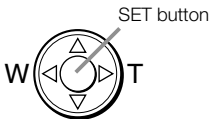



Used for zoom operation and menu operation. Pressing the center acts as the SET button.

## MENU/DISPLAY button

### **MENU button**

Displays menus of various modes.

### **DISPLAY button**

Images can be displayed and recorded using the LCD monitor by pressing the DISPLAY button during Manual mode () and Auto mode (.

## Status LCD

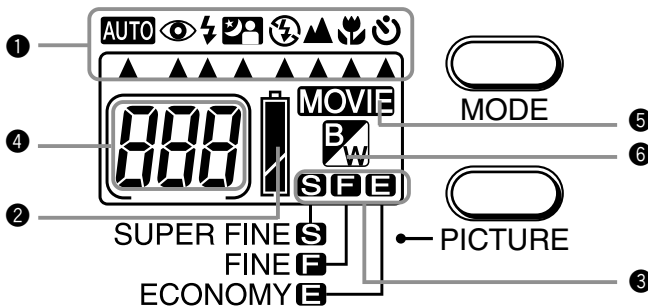

### 1 Camera mode

By selecting a preset recording mode using the MODE button, the subject can be recorded in the optimal condition. 14 modes can be selected using the 8 icons.

- AUTO** (Auto) mode
- AUTO** (Red-eye Reduction) mode
- (Forced Flash) mode
- (Night View Portrait) mode
- (Flash Off) mode
- (Long Distance) mode
- (Macro recording) mode
- (Self-timer) mode

For details on each mode, see Chapter 2 Basic Recording.

### 2 Battery level indicator

When using batteries, the battery level is indicated using 3 levels (full: ; half-full: ; empty: ).

### 3 Picture quality mode

The picture quality of image data can be selected from 3 types by pressing the PICTURE button.

- S** SUPER FINE    **F** FINE    **E** ECONOMY

### 4 Remaining number of frames

Remaining number of frames available for recording is displayed. When the camera is connected to a PC, "PC" is displayed.

### 5 **MOVIE**

This indicator is displayed when the camera is set to movie recording.

### 6

This indicator is displayed when the camera is set to black-and-white recording.

# Installing the Battery/AC Adapter (Optional)

Turn the main switch to the OFF position.

## CR-V3 lithium battery (supplied)

- 1 Open the battery/card cover by sliding it in the direction of the ▼ arrow.



**Warning:** Do not operate with wet hands. Electrical shock may occur as a result.

- 2 Inert the battery in the correct direction as shown in the diagram.
- 3 After checking that the battery has been correctly installed, close the battery/card cover. At this time, check to make sure that the cover is completely closed.

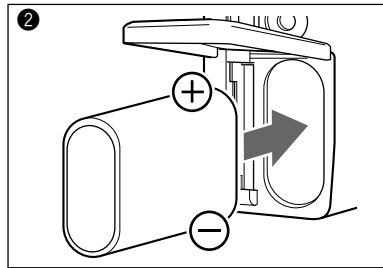
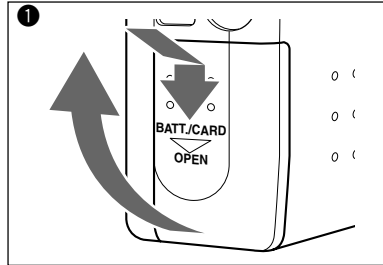

## AA batteries (optional)

- Insert AA batteries (2 units) with polarity as shown in the diagram inside the battery compartment.



**Caution:** Inserting batteries with the polarity incorrect cause battery fluid leakage and heating, resulting in personal injury, defacement, and/or damage to the camera. Don't recharge the battery.

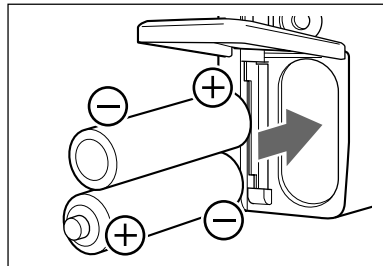

### Note:

- \* AA alkaline batteries and AA nickel-hydrogen batteries can be used.
- \* When using AA alkaline batteries, approximately 150 images can be recorded with the LCD monitor on and 300 images with the LCD monitor off. During continuous playback, the camera can be operated for about 75 minutes. (All values obtained under Konica test conditions.)
- \* When the battery level indicator on the status LCD is less than half, replace the batteries. When replacing AA batteries, replace both with new batteries. When using the camera outdoors, it is recommended that you carry extra batteries.



## Battery life guide (reference)

	Recording (LCD monitor on)	Recording (LCD monitor off)	Continuous playback
CR-V3 lithium battery	About 500 images	About 1250 images	About 300 minutes
AA alkaline batteries	About 150 images	About 300 images	About 75 minutes

\* Under Konica test conditions (room temperature, Super Fine mode, 50% flash, continuous recording at 20 second interval, and one zoom operation in single direction)

### Note:

- \* Battery life varies according to the brand and grade.
- \* The above values are for reference only and are not guaranteed.
- \* Power is consumed by the following operations even when not recording and these will reduce the number of images that can be recorded.
  - Repeated focus operations by pressing the shutter button halfway.
  - Repeated zoom operations.
  - Extensive use of the LCD monitor in the Playback mode.
  - Communication with a PC.



**Warning:** When you continue using the camera for a long time, the batteries become hot. Contact with the batteries can lead to burns.



**Caution:** Do not use new batteries with old ones. Do not use a mix of different types, different manufactures, different classifications of batteries. Do not use rechargeable batteries with substantially different charge status.

## AC adapter (optional)

- Insert the AC adapter into a wall outlet of 100V AC (①). Next, connect the power cable of the AC adapter into the AC adapter jack on the camera (②).



### Handling the AC adapter

- Be sure to read the “Safety Precautions” in this manual (pages 6, 7 and 8).
- Always use the specified AC adapter (DR-AC2). Otherwise fire and/or electrical shock may occur as a result.

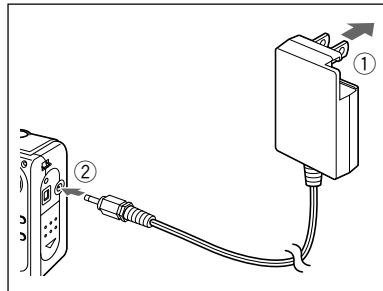

# Inserting/Removing the SD Memory Card/Multi-Media Card

## Application and handling of the SD Memory Card/Multi-Media Card

- Other than saving recorded images, SD Memory Card/Multi-Media Card can also be used for data transfer to a PC (see Chapter 7 “Installing the Software and Transferring Images to a PC” (page 67)). For handling instructions, see “About the SD Memory Card/Multi-Media Card” (page 9).

## Preparation

- Check to make sure that the main switch is set to the OFF position. Damage may occur to the camera and/or SD Memory Card/Multi-Media Card if the power is on.

## Inserting the card

- 1 Open the battery/card cover.
- 2 Face the label of the SD Memory Card/Multi-Media Card toward the front of the camera and securely insert into the camera with the ▲ mark on the label facing up until a click is heard.  
The card will be locked.

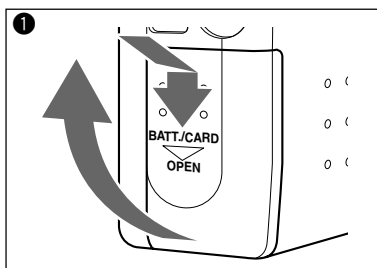

- 3 Close the battery/card cover.



\* SD Memory Card cannot be inserted and locked if the front/back sides or the up/down direction are incorrect.

\* Multi-Media Card will lock with the card ejected if the front/back sides or the up/down direction are incorrect and the battery/card cover will not close.

\* If force is used when inserting SD Memory Card/Multi-Media Card, damage may occur to the connector section.

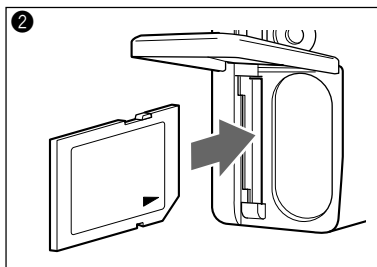

## Removing the card

- 1 Open the battery/card cover.
- 2 Press in the inserted SD Memory Card/Multi-Media Card.  
The card will unlock and eject. (Push-Push system)

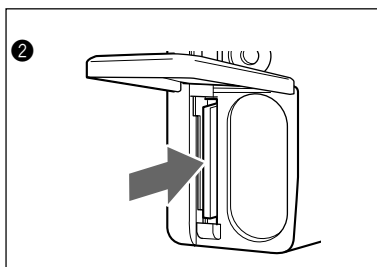

- 3 Close the battery/card cover.



\* Always turn the main switch to the OFF position and make sure the LED is off before inserting/removing the SD Memory Card/Multi-Media Card. When opening the battery/card cover while the card LED is on, card access is interrupted and the unit may stop operating correctly.



\* During image recording, the card LED is lit. While the lamp is on, do not open the battery/card cover or remove the SD Memory Card/Multi-Media Card. Interrupting the writing process will not only cause the camera to malfunction but the card may become unusable.

## Installing the Strap

- 1 Pass the thin loop through the strap into the strap holder on the right side of the camera. If the strap is difficult to pass through, use a toothpick, etc., to pull out the strap.
- 2 Pass the strap through the thin loop and pull.



**Warning:** When using the camera with the strap attached, take care so that it does not wrap around the neck. On no account hang the camera on the neck of small children and infants. Strangulation may occur as a result if the strap wraps around the neck.



\* When carrying the camera hanging from the strap, take care so that it is not accidentally banged.

\* When installing the strap, there is a possibility that the camera could be dropped and damaged. Place the camera on a stable surface before installing the strap.

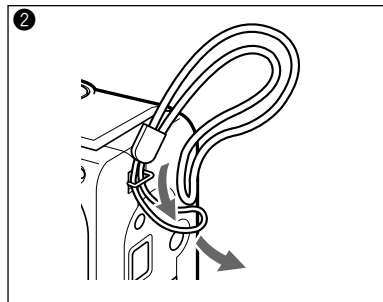
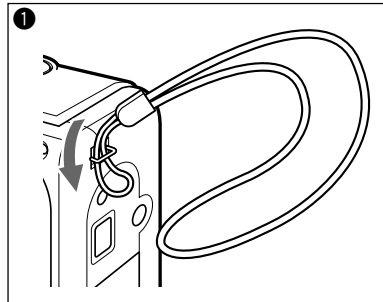

# Adjusting the Menu Display Language and Time/Date

When using the camera for the first time, set the menu display language and time/date. The setting range is between January 1, 2001 and December 31, 2035. (The following shows an example of changing the time and date from 0:00, January 1, 2001 to 10:30, February 14, 2002.)

## Note:

\* The menu language, time and date are maintained by the backup condenser. The setting contents are therefore retained even when replacing the lithium battery/AA batteries.



\* **Backup time during battery replacement is about 15 minutes.**

❶ Check to make sure that new batteries, fully charged battery, or AC adapter have been installed/connected.

❷ Set the main switch to .  
The LCD monitor will turn on and the Language Setting screen will appear.

## Note:

\* The same screen will also appear when setting the main switch to other modes (, , **SET**) with the exception of OFF.

❸ Press the / button to select the desired language and press the SET button.  
The Confirmation screen for the selected language will appear.

❹ Press the button to select “はい” and press the SET button.  
The selected language will be confirmed and the Time/Date Setting screen will appear.

## Note:

\* Selecting “はい” and pressing the SET button will return you to the screen of ❷.

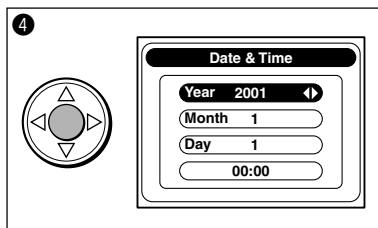
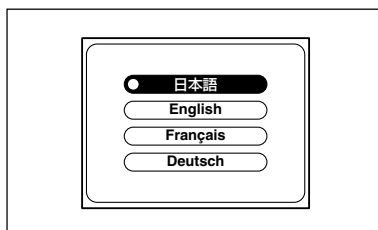
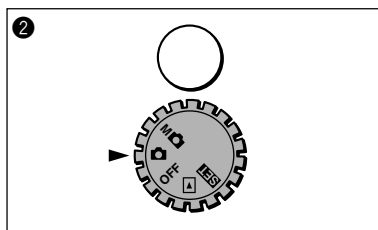

- 5 The "Year" is selected.  
Press the ◀/▶ button to adjust the year.
- 6 Press the ▼ button to select "Month".  
Press the ◀/▶ button to adjust the month.
- 7 Press the ▼ button to select "Day".  
Press the ◀/▶ button to adjust the date.
- 8 Press the ▼ button to select "Time (hour)".  
Press the ◀/▶ button to adjust the time (hour).
- 9 Press the ▼ button to select "Time (minute)".  
Press the ◀/▶ button to adjust the time (minute).

**Note:**

\* When selecting each item in steps 6 through 9 ("Month", "Day", "Time"), the ▲/▼ button can be pressed to return to the earlier setting screens to correct previously set items.

- 10 Press the SET button.  
The Confirmation screen for the date setting will appear.
- 11 Press the SET button again.  
The set values will be stored and the LCD monitor will turn off.

**Note:**

\* Selecting "NO" by pressing the ▶ button and pressing the SET button will return you to the screen of 5.  
\* If **M** is selected in step 2, the LCD monitor will turn off. If **▶** or **SET** is selected, the LCD monitor will remain on and the initial screen of the corresponding setting will appear.

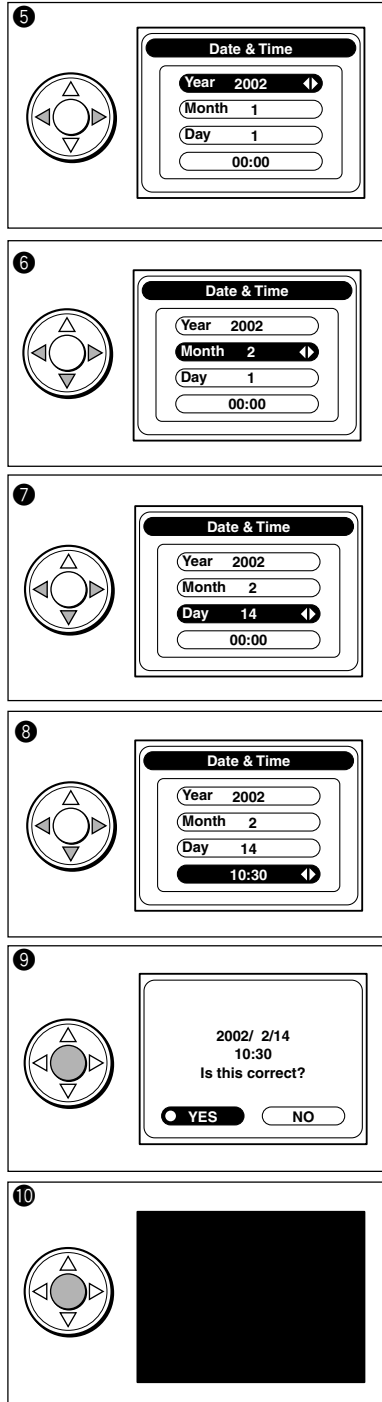

### Holding the camera

- Hold the camera securely in both hands with the elbows pressed against the body for stable positioning.
- When using the flash with the camera held sideways, hold the camera so the shutter button is at the top.

 \* Take caution not to cover the flash or lens with fingers or strap.

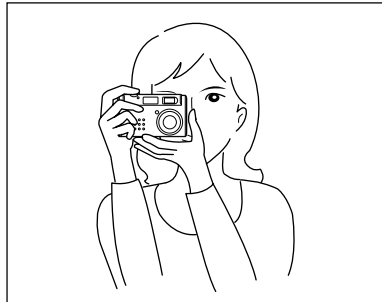

### Viewfinder and LED

For normal recording, aim at the subject using the entire viewfinder area. To focus, position the subject within the diagonally-lined center area of [ ] located at the center of the viewfinder.  
For macro recording (0.25m to 0.8m), or if the zoom position is set to TELE and the distance between the camera and subject is near, record with the LCD monitor set to ON since the viewfinder and the recording range will vary. For macro recording, see page 32.

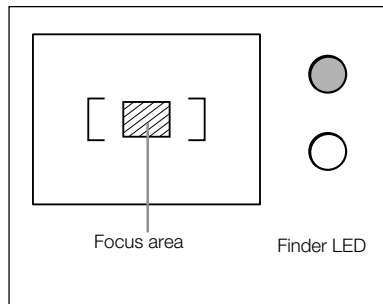

Definitions of viewfinder LED display statuses on the right of the viewfinder are shown below. Use them as references during operation of the camera.

LED display	Status	Definition	Warning sound
Red	Flashing	System error (error code displayed on status LCD)	Yes
Red	Flashing	Image blur warning, Low light warning	No
Red	On	Flash charging	No
Green	Flashing	Auto-focus (AF) unavailable*	No
Green	On	Camera ready for recording	No
Red and green	Flashing	Camera unstable warning, low-luminance warning or when subject cannot be focused (AF)	Yes
Red and green	Flashing	Insufficient card space, or card is not inserted, damaged, unformatted or write-protected	No
Red and green	On	Formatting card or during process	No



\* The LEDs will flash in green even when the distance between the camera and subject is out of the auto-focus range (normal recording: 0.8m ~ ∞, macro recording: 0.25m ~ 0.8m).

## Recording

Normal recording is performed with the subject a distance of more than 0.8m. For distances between 0.25m to 0.8m from the subject, see “🌻 (Macro Recording) mode (page 32)”.



❶ Check to make sure that an SD Memory Card/Multi-Media Card is properly inserted.

❷ Set the main switch on the top of the camera to .  
The lens will extend.

 \* If the main switch is set to  while the lens is being held, “Err” may appear in the status LCD. If this occurs, turn the main switch to OFF and turn it back to .

❸ Press the PICTURE button to set the picture quality of the image data to record. (Default setting is . To change the setting, see “Setting the Picture Quality” (page 28).)

❹ Press the MODE button to set the recording mode. (Default setting is **AUTO**. To change the setting according to the subject, read from “Selecting the Recording Mode” (page 29) to “🕒 (Self-timer) Mode” (page 34).)

❺ Look through the viewfinder to determine the image composition, and then press the  (W) and  (T) buttons to set the subject size. At this time the image is focused, based on the center auto-focus frame within the viewfinder. (See page 22.)

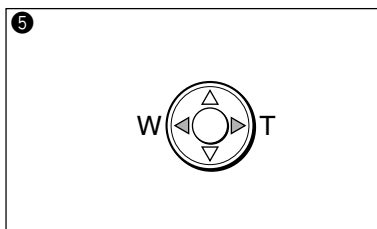
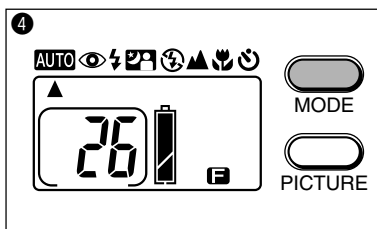
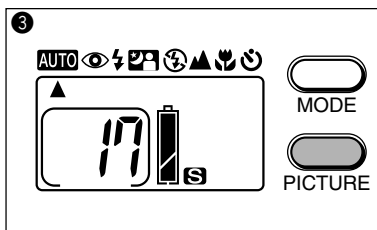
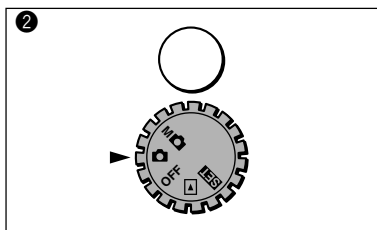

**Note:**

\* When pressing the ◀ (W) button, the subject will become smaller (wide). When pressing the ▶ (T) button, the subject will become larger (telescopic). The zoom function will operate within the range is equivalent to 35 – 105mm in a 35mm camera.

- 6 Lightly press the shutter button (halfway).  
The viewfinder LED will light green and the focus and exposure will be locked.  
If the subject to focus is not in the center of the viewfinder, perform “Focus Lock Recording” (page 25).



See also: “Release Lock” (page 26)

- 7 Gently press the shutter button completely.  
Recording is completed when a buzzer sound is heard.  
The operation of writing the recorded image to the SD Memory Card/Multi-Media Card will start and at the same time, the card access LED on the side of the camera will light (orange). When the card access LED turns off, the writing process is completed.

 \* Do not open the battery cover when the card access LED is lit.

**Note:**

\* The number displayed within the frame of the status LCD indicates the remaining number of images that can be recorded. The remaining number of images varies depending on the capacity of the SD Memory Card/Multi-Media Card and the picture quality mode.

 \* When the battery level indicator is half-full () , replace the battery.

- 8 Set the main switch to OFF.  
The lens will automatically retract.

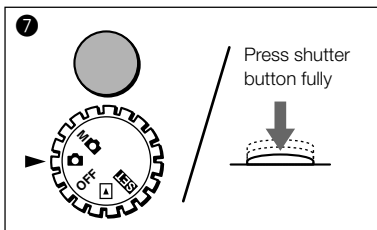
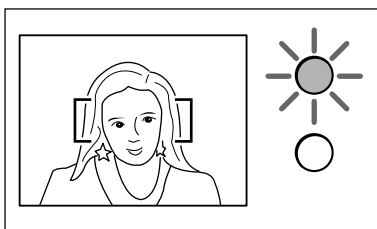
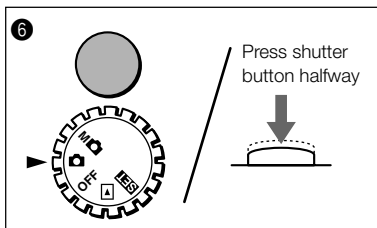



## Focus Lock Recording

Use the following procedure if the subject to record is not in the center of the viewfinder.

- 1 Position the subject so that it falls within the focus frame and lightly press the shutter button (halfway).

The viewfinder LED will light green and the focus position will be locked.

### Note:

- \* Exposure is locked when the viewfinder LED is lit green.
- \* Releasing the finger from the shutter button after locking the focus position will cancel the focus lock. In this case, the focus cannot be re-locked.

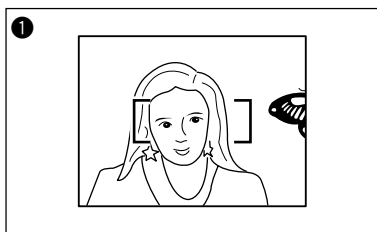

- 2 While continuing to hold the shutter button down lightly (halfway), re-position the subject for the desired composition and gently press the shutter button down completely to record.

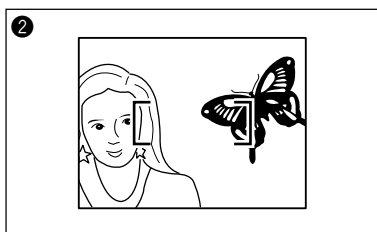

## Recording using the LCD monitor

As well as using the viewfinder, the LCD monitor can be used for recording.

- 1 Set the main switch on the top of the camera to  and press the DISPLAY button. The through image (the image as seen through the lens) will be displayed on the LCD monitor.

- 2 Record by referring to the LCD monitor.

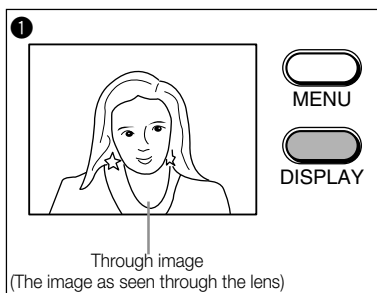

### Note:

- \* Recording procedure is the same as when using the viewfinder.

## Notes and hints concerning recording

### Release lock

Although the exposure and focus will be locked when the shutter button is lightly pressed after determining the image composition in step ⑥ of page 24, the release lock will operate if any of the following conditions apply. In this event, the shutter button cannot be pressed further and recording cannot be completed. A warning sound may also be heard.

- \* When the SD Memory Card/Multi-Media Card is unformatted (Warning sound) (\*1)
- \* When there is insufficient SD Memory Card/Multi-Media Card space (When the remaining number of frames on the status LCD is "0") (Warning sound)
- \* When the memory card is write-protected (Warning sound)
- \* When the camera buffer memory is full from continuous recording (\*2)
- \* Before exposure and focus are locked (Before the viewfinder LED lights or flashes green.)
- \* When an error messages is displayed on the status LCD (See page 22.)

---

\*1 Always format the SD Memory Card/Multi-Media Card using the camera.

For details on formatting, see page 63.

\*2 The time of release lock varies depending on the type of card used and picture mode.

### Image blur warning

If there is a possibility of the image becoming blurred during recording, the viewfinder LED will flash red.

### Auto shut-off function

When using the camera with batteries and no operation is made for a certain time, the camera power will automatically turn off to prevent battery depletion. (When the power turns off, the LCD monitor will also turn off depending on the mode.)

To recover from auto shut-off, press the MODE button, PICTURE button, ▲/▼/◀/▶ button, shutter button or DISPLAY button.

The time for auto shut-off is factory set to "3 min", and the setting can be changed in the SET-UP menu. (See page 64.)

### Remaining number of frames display

Depending on the recorded subject, the remaining number of frames left for recording may not change.

#### Note:

\* The auto shut-off function operates even when using the AC adapter.

## Checking the recorded image (quick review)

By setting quick review to ON in the SET-UP menu (see “Setting quick review” (page 65)), the recorded image can be checked for about 3 seconds after it is recorded.

- **When using the viewfinder to record and the LCD monitor is off:**

When recording is completed, the LCD monitor will automatically turn on to play back the recorded image for about 3 seconds.

To save, press the SET button.

To delete, use the ► button to select “NO”, and then press the SET button.

(If there is no key operation within the 3 seconds, the image is automatically saved and the LCD monitor is turned off.)

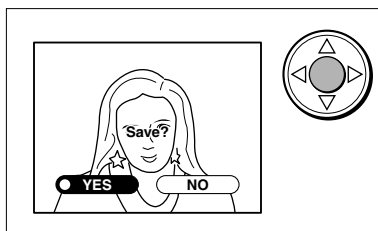

- **When recording using the LCD monitor:**

When recording is completed, the recorded image is played back for about 3 seconds.

To save, press the SET button or the shutter button.

To save, press the SET button.

To delete, use the ► button to select “NO”, and then press the SET button.

(If there is no key operation within the 3 seconds, the image is automatically saved and returns to displaying the through image.)

# Setting the Picture Quality

By using the PICTURE button, the picture quality of the image data to be recorded can be selected from 3 types. The currently selected picture quality is displayed on the status LCD. Pressing the PICTURE button will cycle through the picture quality modes as shown below.

- S** SUPER FINE (Default setting)
- F** FINE
- E** ECONOMY

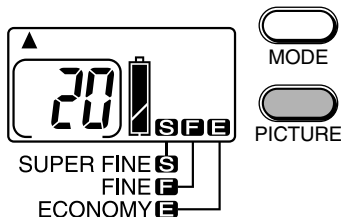

## Number of recordable images

The values shown below are guides when recording using the same picture mode. When there are files other than images, or when recording is made while switching the picture quality mode/recording mode, the number of recordable images will vary. Furthermore, the number of recordable images may also vary depending on the recorded subject.

Picture quality mode	Estimated number of recordable images (8MB card)	File size (estimate)
SUPER FINE	About 17 images	About 400KB
FINE	About 26 images	About 250KB
ECONOMY	About 60 images	About 100KB

\*Note: When using an SD Memory Card

## Picture quality modes and number of recorded pixels

Picture quality mode	Number of recorded pixels (H) × (V)	Picture quality
SUPER FINE	1600 × 1200 pixels	The camera is set to this mode as default. Among the 3 picture quality modes, this mode is superior in quality. Use this mode when saving images or when editing images on a PC. Images consisting of about 2 million pixels can be recorded in this mode.
FINE	1280 × 960 pixels	Images consisting of about 1.3 million pixels can be recorded in this mode.
ECONOMY	640 × 480 pixels	Among the 3 modes, this mode allows the most number of images to be recorded. Since the image file size is small, images recorded in this mode are suitable for attaching to email, etc.

### Picture quality mode and display

When playing back images record in the above picture modes, the 3 mode types will appear on the center bottom of the LCD monitor.

[SUPER FINE] → **S**, [FINE] → **F**, [ECONOMY] → **E**

# Selecting the Recording Mode

By selecting a preset recording mode using the MODE button, the subject can be recorded in the optimal condition. 14 modes can be selected using the 8 icons. The current setting can be checked on the icon display of the status LCD.

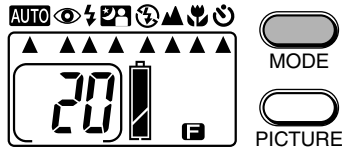

Every time the MODE button is pressed, the recording mode changes as shown below.

	AUTO	eye	lightning bolt	portrait	globe	triangle	flower	power
Auto	▲							
Red-eye Reduction	▲	▲						
Forced Flash			▲					
Night View Portrait				▲				
Flash Off					▲			
Long Distance						▲		
Macro Recording							▲	
Self-timer/auto	▲							▲
Self-timer/red-eye reduction	▲	▲						▲
Self-timer/forced flash			▲					▲
Self-timer/night view portrait				▲				▲
Self-timer/flash off					▲			▲
Self-timer/long distance						▲		▲
Self-timer/macro recording							▲	▲

**Note:**

- When pressing the ◀ button with holding the MODE button down, the MODE changes in reverse order.
- During auto power-off, the setting of each mode is saved. (👤 Night View Portrait mode and ⏻ Self-timer mode are canceled.)
- **Jump function:**  
When power is turned off, the mode returns to **AUTO** (default setting). However, the previously set mode can be selected by pressing the MODE button once. (Self-timer is not included as a previous set mode.)
- **Single-action AUTO function:**  
Pressing the MODE button for 2 seconds will return the mode to **AUTO**.

For details concerning each mode, see the respective pages.

- AUTO** (p.30)  
 **AUTO** eye (p.30)  
 lightning bolt (p.30)  
 👤 (p.31)  
 globe (p.31)
- ▲ (p.31)  
 flower (p.32)  
 ⏻ (p.34)

## AUTO (Auto) Mode

Since this mode automatically performs all settings, it allows you to concentrate on the actual image to record. When recording in a dark place or against backlight, the camera will automatically determine whether the flash is necessary.

- Press the MODE button and select **AUTO**.

### Note:

- \* The flash recording range is 0.8 to 3.0m when the camera is set to WIDE and 0.8 to 2.0m when set to TELE (the range varies depending on the zoom position and aperture). When the subject is closer than the minimum flash range, the screen will become brighter. When further than the maximum flash range, the screen will become darker.
- \* While the flash is being charged, the viewfinder LED will light in red. While the LED is on, flash recording cannot be made. When continuously using the flash for recording, check to make sure that the LED on the viewfinder is off.



## AUTO (Red-eye Reduction) Mode

Preliminary flashing is performed before the actual flash to reduce the red-eye effect. Other than the preliminary flash, the mode is the same as **AUTO**.

- Press the MODE button and select **AUTO** .

### Note:

- \* The red-eye reduction may have little effect if the subject is not directly facing the preliminary or actual flash, or when there is some distance between the camera and subject.

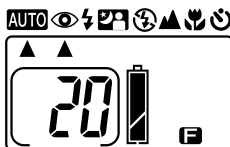

## (Forced Flash) Mode

Used to soften dark shadows on the face of the subject due to backlight, artificial lighting, etc. The flash will always be used regardless of the surrounding brightness.

- Press the MODE button and select .

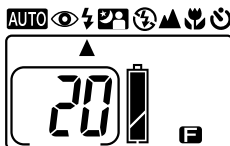

## (Night View Portrait) Mode

Used when recording subjects with night view as the background. The flash and red-eye reduction will always be used.

Under low light conditions, the shutter speed will become slow. Since this may result in the image becoming blurred, use of a tripod is recommended.

- Press the MODE button and select .

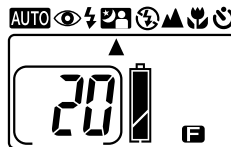

## (Flash Off) Mode

Used when recording in a place where flash photography is prohibited, or when utilizing the night view or indoor lighting for recording. The flash will always be off during recording.

Under low light conditions, the shutter speed will become slow. Since this may result in the image becoming blurred, use of a tripod is recommended.

- Press the MODE button and select .

**Note:**

\* If the subject is moving, the image will appear blurred.

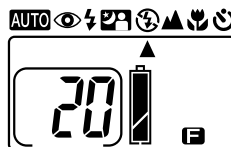

## (Long Distance) Mode

Used when recording scenery. The flash will always be off during recording.

- Press the MODE button and select .

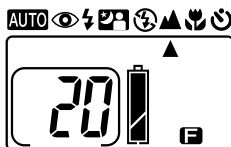

## (Macro Recording) Mode

Used when recording the subject at close distances.

Macro recording is used when the subject is within a distance range of between 0.25m and 0.8m from the front of the lens.

For macro recording, the flash will always be off. Under low light conditions, the shutter speed will become slow. This may result in the image becoming blurred.

When using macro recording, the use of a tripod is recommended.

 **Caution:** For macro recording, the recording range and the field of view within the viewfinder will differ. Use the LCD monitor for recording.

- 1 Set the main switch on the top of the camera to .

The lens will extend.

- 2 Press the PICTURE button and set the required picture quality of the image data to record.

- 3 Press the MODE button and select .

- 4 Press the DISPLAY button.

Through image (the image as seen through the lens) will be displayed on the LCD monitor.

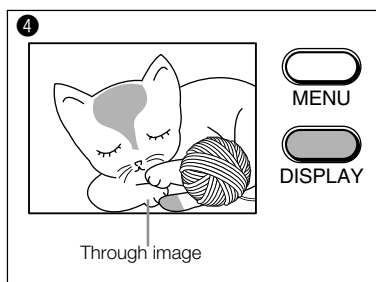
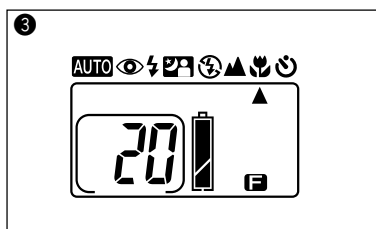
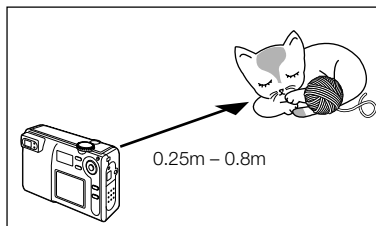



- 5 While viewing the LCD monitor, press the ◀ (W) and ▶ (T) buttons to adjust the subject size and image composition.
- 6 Lightly press the shutter button (halfway). The viewfinder LED will light green and the exposure and focus will be locked.
- 7 Gently press the shutter button completely. Image recording is completed when the buzzer sound is heard.

**Note:**

- \* Focus adjustment in the macro recording mode may take longer than usual.
- \* Focus adjustment may be difficult for the following:
  - A location where the subject or background is extremely dark.
  - Objects with no contrast (sky, white wall, car hood, etc.), flat objects with only horizontal lines, fast moving objects, poorly lit objects (dark places), objects with strong backlight or reflecting light, and objects that flicker such as fluorescent lighting.

## (Self-timer) Mode

This mode automatically releases the shutter after a delay so that the person making the recording can be included in the image.

When using the self-timer, the camera must be fixed on a stable surface. The use of a tripod is recommended.

The shutter is released approximately 10 seconds (default setting) after the shutter button is pressed.







- 1 Set the main switch on the top of the camera to .



The lens will extend.

- 2 Press the PICTURE button and set the required picture quality of the image data to record.

- 3 Press the MODE button and select .

### Note:

\* The self-timer can be used with **AUTO**, **AUTO** , , , ,  and  modes.

- 4 Look through the viewfinder to adjust the image composition, and press the  (W) and  (T) buttons to set the subject size.

- 5 Lightly press the shutter button (halfway), and then gently press the button down completely.

The self-timer LED on the front of the camera will flash in red and the shutter will be released after about 10 seconds.

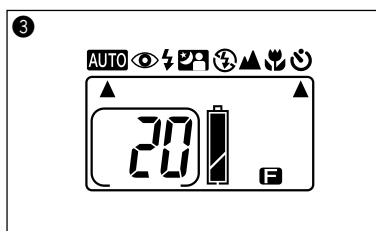

### Note:





\* To cancel the self-timer during operation, select a mode other than  using the MODE button.

\* The self-timer function is cancelled after each recording. To continue using the self-timer, set the self-timer again.





\* The delay time for the self-timer can be set to either "10 sec" (default setting) or "3 sec" in the SET-UP menu. (See page 63.)

# Adjusting the Screen Contrast

The screen contrast can be adjusted depending on the recording location.

- 1 Set the main switch on the top of the camera to .  
The lens will extend.
- 2 Press the MENU button and enter the REC menu mode.  
“Screen Contrast” will be selected.
- 3 Press the  button to enter the “Screen Contrast” menu and use the  and  buttons to adjust the brightness.

**Note:**

- \* The screen will become darker with the  button and brighter with the  button.
- \* Pressing the  button will return the screen to .

- 4 Press the SET button and exit the REC menu mode.  
Through image will again be displayed on the LCD monitor.

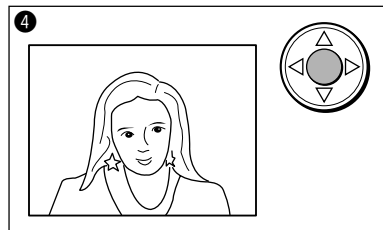
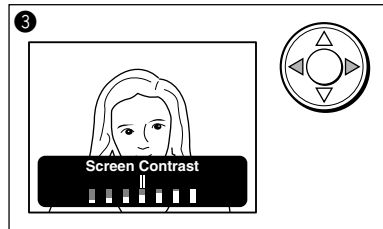
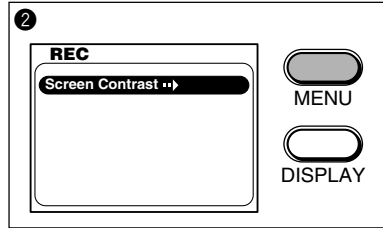



# Chapter 3 Advanced Recording

## Using the M-REC menu

The main switch of the camera can be set to **M**  , so that recording can be made with user-defined settings.

- 1 Set the main switch on the top of the camera to **M**  .



The lens will extend.

-  \* If the main switch is set to **M**  with the lens is being held, "Err" may appear in the status LCD. If this occurs, turn the main switch to OFF and then turn it back to **M**  .

- 2 Press the MENU button to enter the M-REC menu mode.

The M-REC menu screen will appear.

- 3 Press the  /  button to select the desired menu.

The menu will change as follows every time the  /  button is pressed.

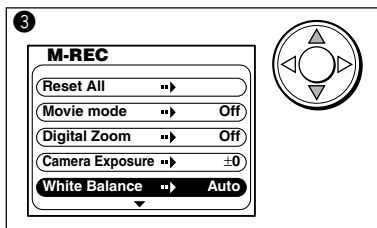
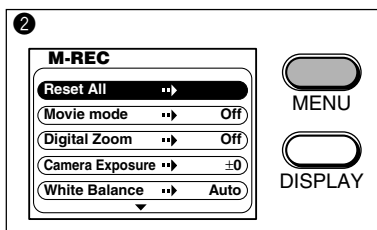
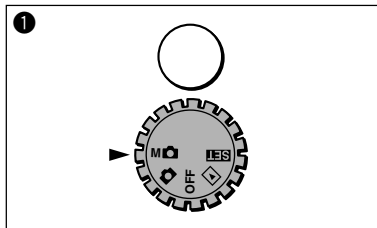
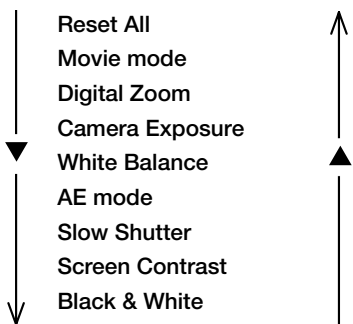

- 4 Press the ◀/▶ button to change the menu setting.

**Note:**

\* To continue with settings, repeat steps 3 and 4.

- 5 Press the SET button to exit the M-REC menu mode. Through image will be displayed on the LCD monitor.

- 6 Record using the set conditions. (See “Recording” (page 23).)

**Note:**

\* The menu settings that have been made will be saved even when the power is turned off.

\* The settings set in the M-REC menu will not be have any effect when the main switch is set to 📷 (auto mode).

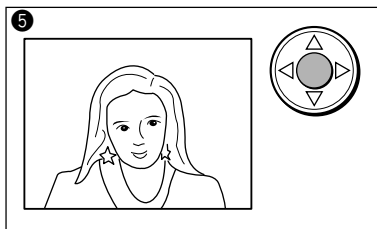
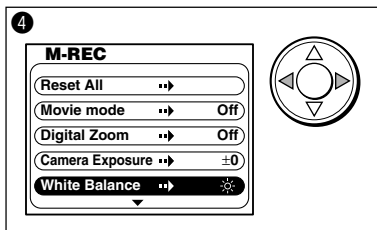

# Recording a Movie

Movies can be recorded with this camera. The available recording resolutions are: 320 X 240 pixels and 160 X 120 pixels. The maximum recording time for a movie is about 15 seconds and recording continues while the shutter button is held down.

**Note:** When the movie mode is set, all menus with the exception of “Reset All” and “Screen Contrast” will become unavailable. (Each menu can again be accessed by turning the movie mode off.)

① Enter the M-REC menu mode and press the ▲/▼ button to select “Movie mode”.

② Press the ◀/▶ button to select the menu content.

The setting will change as follows every time the ◀/▶ button is pressed.

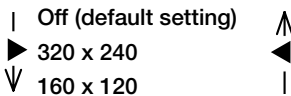

③ Press the SET button to exit the M-REC menu mode. Through images will be displayed on the LCD monitor with a yellow frame.

And the resolution will be displayed in the upper left of the screen, and the recording time will be displayed in the upper right of the screen.

④ Record the movie.

The movie will be recorded while the shutter button is held down.

During recording, “REC” will appear on the right side of the screen in red and the recorded time will be displayed.

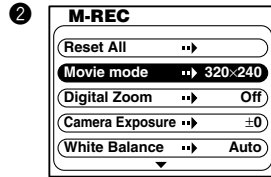
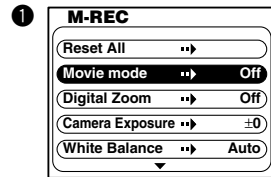

Yellow frame Through image

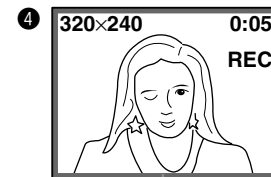

Yellow frame

**Note:**

- \* When movie mode is selected, the **MOVIE** icon will appear on the status LCD.
- \* When the movie mode is selected and the main switch is set to **M**, the LCD monitor will automatically turn on and display through image. (The LCD monitor will not turn off even when pressing the DISPLAY button.)
- \* The optical zoom will not operate during movie recording. (Perform the operation before pressing the shutter button.)

# Using the Digital Zoom

By combining the optical zoom (3x) and digital zoom (1.5x, 2x), images can be recorded with a zoom of 4.5 times to 6 times the original size.

The digital zoom can only be used when optical zoom is set to TELE (3x).

- 1 Enter the M-REC menu mode and press the ▲/▼ button to select “Digital Zoom”.
- 2 Press the ► button to select “On”.
- 3 Press the SET button to exit the M-REC menu mode.
- 4 Press the ► button until the optical zoom stops. Then, release the 5 WAY button and press the ► button again.  
A blue frame will appear on the LCD monitor and the magnification ratio will be displayed on the top right.  
Use the LCD monitor as the viewfinder for recording.

**Note:**

- \* Pressing the ◀/▶ button each time will switch the magnification between 1.5x and 2x (zoom magnification will not change if the button is held down).
- \* Digital zoom cannot be used when the LCD monitor is off.
- \* When using digital zoom, the picture quality may decrease compared to images recorded under normal conditions.

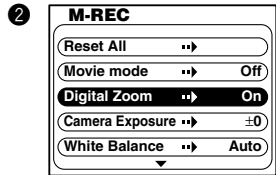
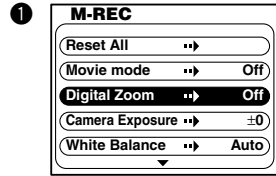

Blue frame

# Exposure Compensation

The exposure can be compensated to intentionally brighten or darken the overall recorded image. The camera exposure can be adjusted within the range of  $\pm 1.5\text{EV}$  at  $0.3\text{EV}$  intervals.

- 1 Enter the M-REC menu mode and press the  $\blacktriangle/\blacktriangledown$  button to select "Camera Exposure".
- 2 Press the  $\blacktriangleleft/\blacktriangleright$  button to adjust the exposure compensation.

**Note:**

\* Pressing the  $\blacktriangleleft$  button will darken the image and the  $\blacktriangleright$  button will lighten the image.

- 3 Press the SET button to exit the M-REC menu mode.

**Note:**

\* The result after setting the camera exposure may not be obvious. In such case, it is recommended to record multiple images with different camera exposure settings and later select the best image.

\* The result of compensation may be insufficient when using the flash.

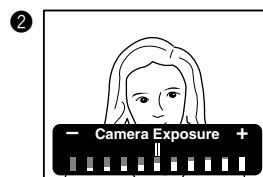
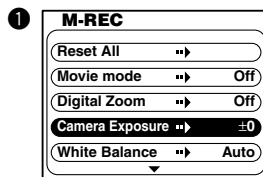



# Changing the White Balance

The white balance can be adjusted so that images can be recorded in natural colors no matter what light source the subject is exposed to.

❶ Enter the M-REC menu mode and press the ▲/▼ button to select “White Balance”.

❷ Press the ◀/▶ button to change the setting.

The setting changes as shown below every time the ◀/▶ button is pressed.

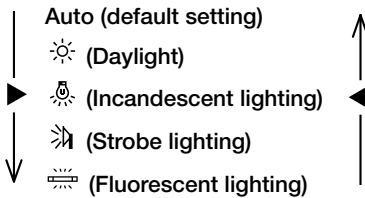

❸ Press the SET button to exit the M-REC menu mode.

**Note:**

\* When there are multiple light sources or when the subject is under special lighting, the desired result may not be achieved.

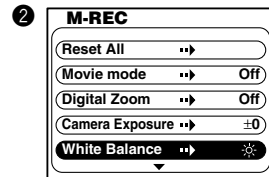
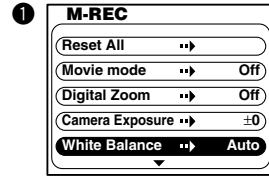

# Changing the AE mode

For normal setting, the AE mode is set to center weighted light reading. The mode can also be changed to spot reading.

In spot reading, the exposure can be adjusted based on a selected position of the subject.

- 1 Enter the M-REC menu mode and press the ▲/▼ button to select “AE mode”.
- 2 Press the ◀/▶ button and select “Regular” or “Spot”.
- 3 Press the SET button to exit the M-REC menu mode.

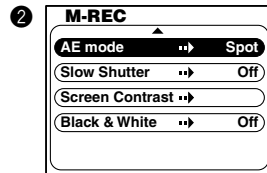
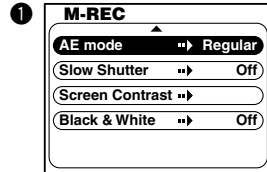

# Changing to Slow Shutter Speed

The normal shutter speed (when slow shutter is off) is between 1/2000 and 1/8 seconds, but by turning on Slow shutter mode, the range can be extended to between 1/2000 and 2 seconds.

- 1 Enter the M-REC menu mode and press the ▲/▼ button to select “Slow Shutter”.
- 2 Press the ◀/▶ button and select “On”.
- 3 Press the SET button to exit the M-REC menu mode.

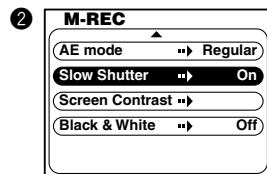
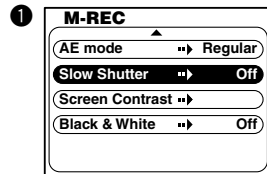

**Note:**

\* The slow shutter setting can only be used during Night view portrait, flash off, Long distance and macro recording modes.

\* Use a tripod for stabilizing the camera.

# Adjusting the Screen Contrast

The screen contrast can be adjusted according to the brightness of the recording location.

- 1 Enter the M-REC menu mode and press the ▲/▼ button to select “Screen Contrast”.
- 2 Press the ► button to enter the “Screen Contrast” menu and press the ◀/▶ button to adjust the brightness.
- 3 Press the SET button to exit the M-REC menu mode.

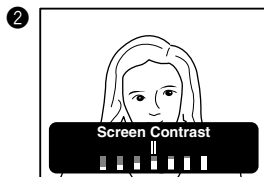
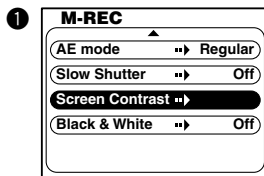

# Recording in black and white

Used for expressing a nostalgic feeling similar to using black-and-white film, or for recording characters on a magazine, blackboard, etc. as memos.

- 1 Enter the M-REC menu mode and press the ▲/▼ button and select “Black & White”.
- 2 Press the ► button and select “On”.
- 3 Press the SET button to exit the M-REC menu mode. Through image on the LCD monitor will be displayed in black-and-white.

**Note:**

\* When “Black & White” is selected, the black-and-white icon  will be displayed on the status LCD.

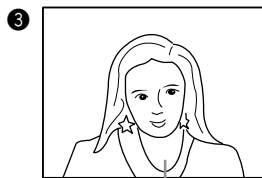
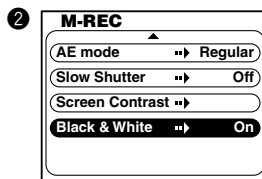
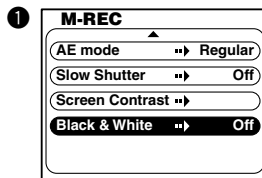

Black-and-white through image

# Resetting the Camera to Default Settings

Various settings made in the M-REC menu can be reset to default settings. (See below)

- 1 Enter the M-REC menu mode to select "Reset All".
- 2 Press the ► button to enter the "Reset All" menu and press the ◀ button to select "YES".
- 3 When the SET button is pressed, all settings will return to the default settings and the M-REC menu mode will end.

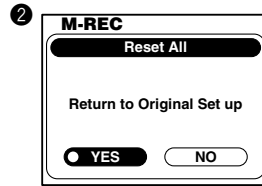
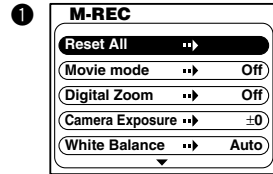

## Default settings are:

Movie mode	Off
Digital Zoom	Off
Camera Exposure	± 0
White Balance	Auto
AE mode	Regular
Slow Shutter	Off
Black & White	Off

### Note:

\* The camera mode (page 15 ❶) and picture quality mode (page 15 ❷) are not reset.

# Chapter 4 Basic Playback

## Playing Back Images

Recorded images can be displayed on the LCD monitor.

**Note:** If, after recording, the main switch is set to , the camera will not enter playback mode until the card access LED is off. (When the card write process is completed, the camera will automatically enter playback mode.)

- 1 Set the main switch on the top of the camera to .

The latest image recorded will be displayed.

**Notes:**

- \* Movies will be displayed inside a yellow frame.
- \* When there is no image data, the message "No picture in camera" will appear. (\*1)

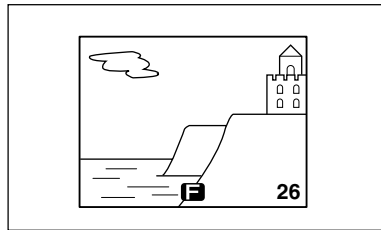
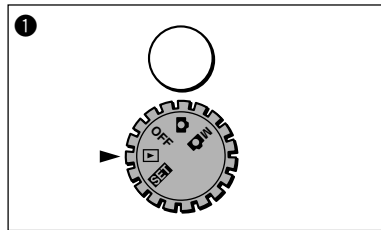

- 2 Previously recorded images will be displayed each time the ◀ button is pressed. Succeeding images will be displayed each time the ▶ button is pressed.

**Note:**

- \* The image will first appear jagged. The image will become clear in a few moments. Images can be forwarded even before they become clear.

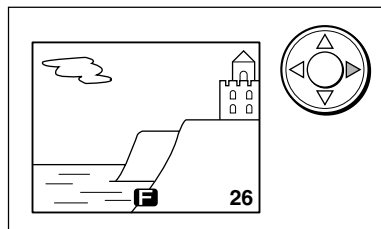
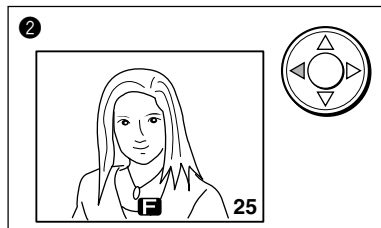

# About the Playback Screen

Other than images, the LCD monitor displays the following:

## File no. (displayed only when the image number is set to ON)

The directory number and file number recorded on the card are displayed. These registration numbers are assigned uniquely to each image and used when creating DPOF files (page 57). (\*2) (\*3)

## Date display (displayed for 3 seconds during playback)

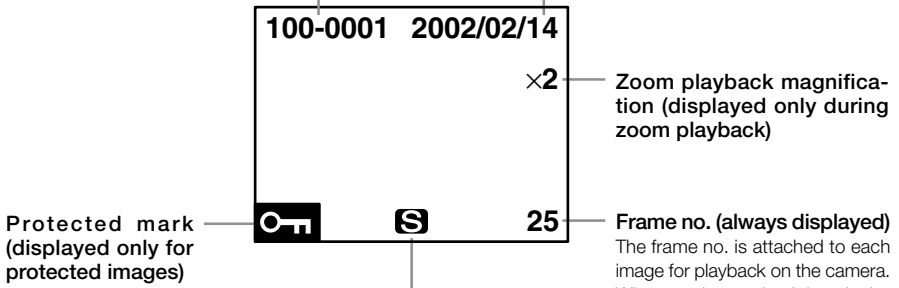

## Picture quality mode (always displayed)

The picture quality type of the recorded image is displayed.

- S** Superfine
- F** Fine
- E** Economy
- M** Movie

(\*1)

The maximum number of frames this camera can play back is 999. If there are more than 999 images on an SD Memory Card/Multi-Media Card, the camera may not play back the images properly.

(\*2)

This camera can play back image files that comply with the DCF (Design rule for Camera File system) standard. (Images taken with products from other companies (that comply with the DCF standard) may also be played back. However, the memory card must either be an SD Memory Card or Multi-Media Card.)

(\*3)

Some of the camera functions (erase, etc) will not be available for image files taken with products from other companies.

## Displaying images at 2× magnification

- ❶ Select the image to display.
- ❷ Press the SET button.  
The center of the image will be displayed at magnification of 2×.

**Note:**

- \* Magnified images are displayed inside a blue frame.
- \* The picture quality mode and frame number are not displayed.

- ❸ Press the ▲/▼/◀/▶ button to scroll the image and display the desired portion.

**Note:**

- \* Pressing the SET button will return the screen to ❶.

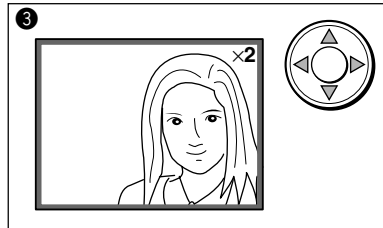
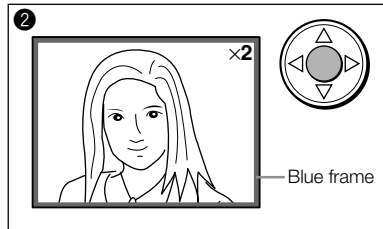
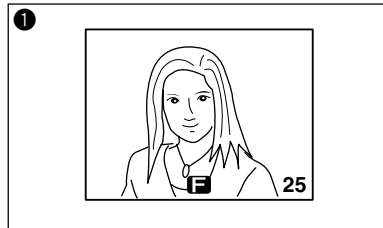

## Playing Back Movies

- ❶ Select the movie to play back.

**Note:**

- \* Movies are displayed in a yellow frame.
- \* Movies may take some time to display.

- ❷ Press the SET button.  
The playback of the movie will start.

**Note:**

- \* All information displays will be cleared at the time of playback.
- \* The yellow frame will not be displayed during playback.
- \* Playback cannot be started when the viewfinder LED is on (red/green) or the card access LED is on.

- ❸ During playback:  
Press the SET button to stop playback and return to the initial screen.  
Press the ▼ button to pause. Press the ▼ button once more to resume playback.  
When playback is finished, the screen returns

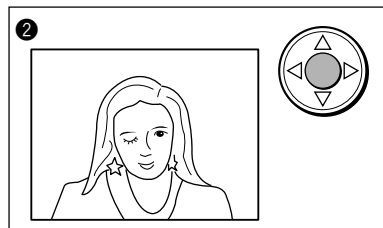
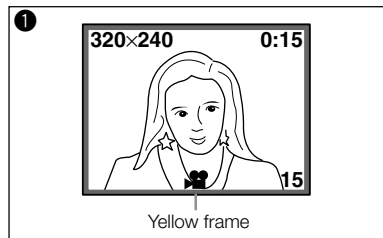



# Chapter 5 Advanced Playback/Erasing

## Using the PLAY Menu

By using the PLAY menu, various playbacks can be made as well as editing of images that are no longer required.

- 1 Set the main switch on the top of the camera to .  
The last image recorded will be displayed.

**Note:**

\* Movie images will be displayed inside a yellow frame.

- 2 Press the MENU button and enter the PLAY menu mode.  
The menu screen will be displayed.

- 3 Press the ▲/▼ button to select the desired menu.

The menu changes as shown below every time the ▲/▼ button is pressed.

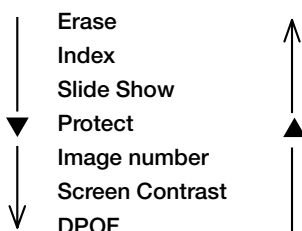

- 4 Use the ◀/▶ button to select the menu content.
- 5 Press the SET button to exit the PLAY menu mode.

**Note:**

\* The settings made will be saved even when the power is turned off.

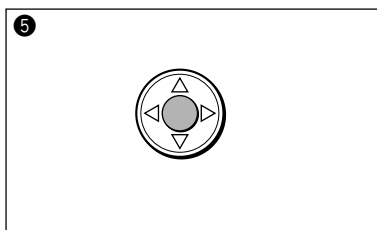
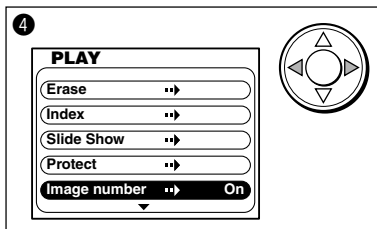
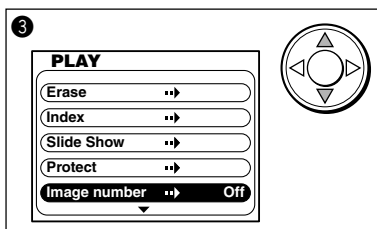
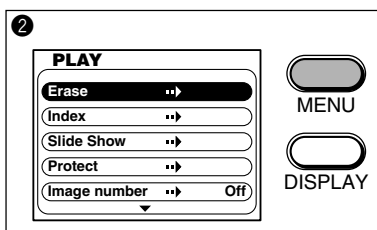
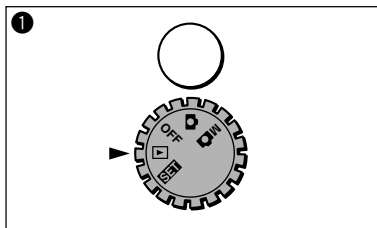

# Erasing Images

Displayed images can be erased one image at a time or all recorded images can be erased at one time.

## Erasing one frame

- 1 Display the image to erase on the LCD monitor.
- 2 Press the MENU button and enter the PLAY menu mode.  
"Erase" will be selected.
- 3 ► button to enter the "Erase" mode and press the ▲ button to select "This".

**Note:**

\* If "NO" is selected and the SET button is pressed, the camera will return to the normal playback screen.

- 4 Press the SET button.  
The displayed image will be erased and the following image will be displayed.

**Note:**

\* When the last frame is erased, the image before the frame that was erased will be displayed on the LCD monitor.

\* Image number following the frame erased will be re-assigned.

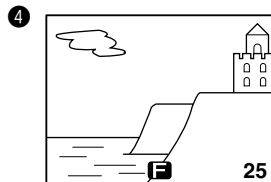
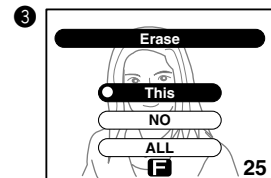
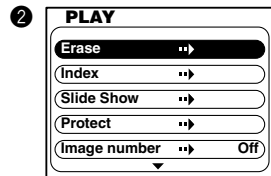
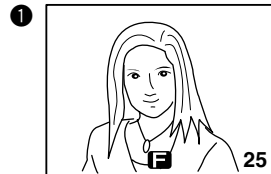

## Erasing all frames

- 1 Press the MENU button and enter the PLAY menu mode.  
“Erase” will be selected.
- 2 Press the ► button to enter the “Erase” menu and press the ▼ button to select “ALL”.
- 3 Press the SET button.
- 4 Press the ◀ button to select “YES”.
- 5 Press the SET button.  
After “Erasing ALL Pictures...” is displayed, all images are erased and “No Picture in Camera” is displayed.

### Note:

- \* If there are one or more protected images, the last frame is displayed.
- \* Erasure time may take some time when erasing many frames or when using a Multi-Media Card.

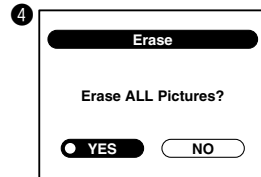
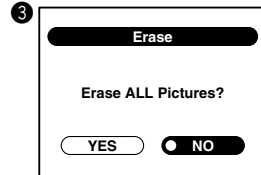
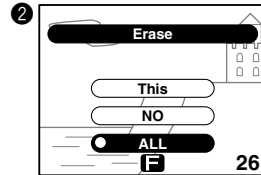
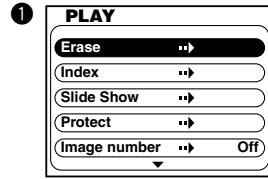



# Viewing Multiple Images (Index Playback)

Images of 9 frames are displayed at one time on the LCD monitor. This function is useful for quickly locating the desired image to display.

- 1 Enter the PLAY menu mode and press the ▲/▼ button to select "Index".
- 2 Press the ► button.  
Images of 9 frames will appear at one time.

## Note:

- \* The image displayed at the time of entering the menu is displayed inside a red frame within the index screen.
- \* The select frame is displayed with a red frame.
- \* Movie images are displayed with , and protected images are displayed with .

- 3 Press the ◀/▶/▲ and ▼ buttons to select the desired image.
- 4 Press the SET button.  
The selected image will be displayed in the normal display mode.

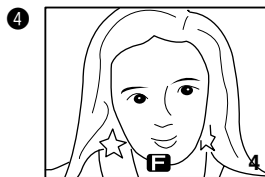
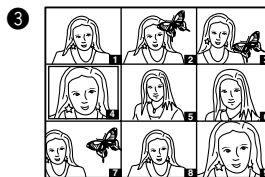
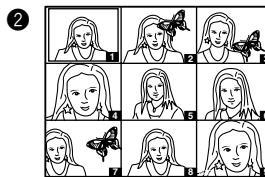
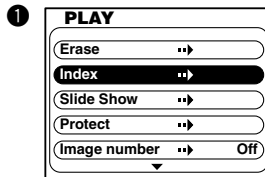

# Viewing a Slideshow of Images

Recorded images can be checked by playing back at specific intervals.

- 1 Enter the PLAY menu mode and press the ▲/▼ button to select "Slide Show".
- 2 Press the ► button.  
The slideshow confirmation screen will appear.  
"YES" will be selected.

**Note:**

\* If "NO" is selected using the ► button and the SET button is pressed, the camera returns to the normal playback screen.

- 3 Press the SET button.  
Slideshow will start with the first frame and each frame will be displayed in order at an interval of 3 seconds.
- 4 During playback:  
Press the SET button to stop playback. The image displayed when stopping playback will be displayed in the normal playback mode.  
Press the ► button to move to the next image.  
Press the ▼ button to pause.  
Press the ▼ button to resume.
- 5 When playback is finished, the display will stop at the final frame.

**Note:**

\* The frame playback interval of 3 seconds cannot be changed.

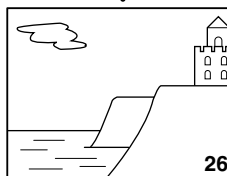
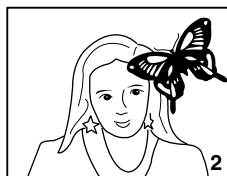
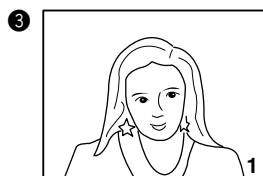
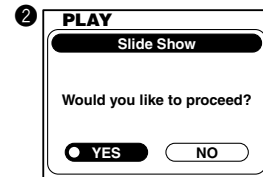
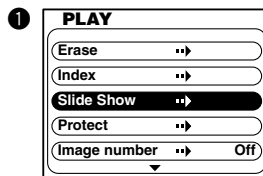

# Keeping Important Images (Protect Setting)

Recorded images can be protected to prevent them from being accidentally erased.

## Applying the protect setting

- 1 Display the image to protect on the LCD monitor.
- 2 Enter the PLAY menu mode and press the ▲/▼ button to select "Protect".

- 3 Press the ► button.  
The Protect confirmation screen will appear.  
"YES" is selected.

### Note:

- \* In the protect confirmation screen, the frame number of the screen is displayed on the lower right.
- \* If "NO" is selected using the ► button and the SET button is pressed, the camera will return to the normal playback screen.

- 4 Press the SET button.  
The image will be protected and the protected mark (🔒) will appear.

### Note:

- \* Protected images will not be deleted even when erasing all frames.

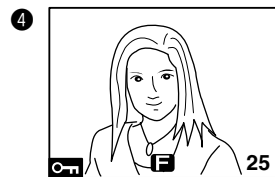
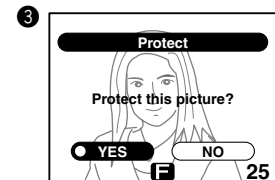
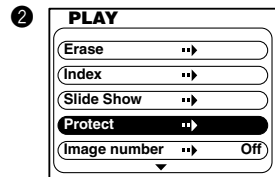
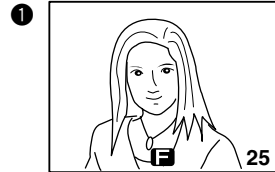

## Removing the protect setting

- 1 Display the protected image on the LCD monitor.
- 2 Enter the PLAY menu mode and press the ▲/▼ button to select “Protect”.
- 3 Press the ► button.  
The protect confirmation screen will appear.  
“YES” will be selected.
- 4 Press the ► button to select “NO”.
- 5 Press the SET button.

The protect setting will be removed from the image and the protected mark (  ) will disappear.

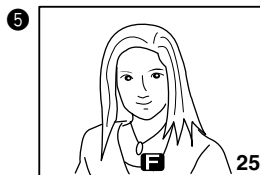
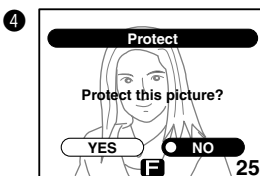
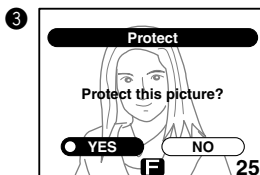
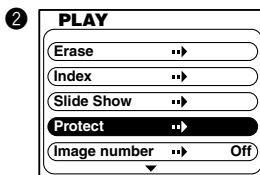
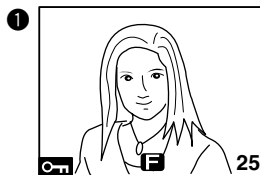

## Displaying the file number

The file no. can be displayed on the image being played back. (See page 47.)

- 1 Enter the PLAY menu mode and press the ▲/▼ button to select "Image number".
- 2 Press the ► button and select "On".
- 3 Press the SET button.  
The camera returns to the normal playback display and the file no. will be displayed on the image.

### Note:

\* When selecting "Off" and pressing the SET button or MENU button, the file no. will be cleared from the image.

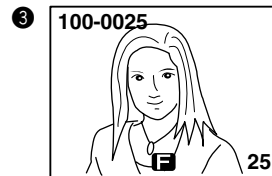
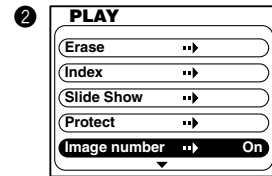
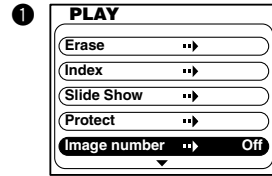

## Adjusting the Screen Contrast

The screen contrast can be adjusted according to the brightness of the playback location.

- 1 Enter the PLAY menu mode and press the ▲/▼ button to select the "Screen Contrast".
- 2 Press the ► button to enter the "Screen Contrast" menu and press the ◀/▶ button to adjust the brightness.
- 3 Press the SET button to exit the PLAY menu mode.

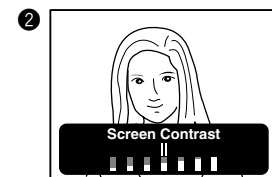
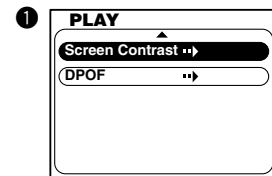



# Selecting the Image to Print (DPOF)

## Images cannot be printed by the camera itself.

This menu is for giving instructions about the images and the quantity of print required for automatic output of images within a card to a DPOF (\*1) compatible digital printer. There are 2 types of specifications: single frame specification and all frame specification.

A DPOF file is automatically created on the card and the order data is recorded within this file.

(\*1) DPOF: abbreviation for Digital Print Order Format

**When printing images using the DPOF function on your own printer, first check with the printer manufacturer to make sure that your printer is DPOF compatible.**

**Note: Image can be printed from the created DPOF file only if your printer is DPOF compatible.**

## Selecting images (single frame/all frames)

- 1 Enter the PLAY menu mode and press the ▲/▼ button to select "DPOF".
- 2 Press the ► button to enter the "DPOF" menu.  
"Set up" will be selected.
- 3 Press the SET button.
- 4 Press the ▲/▼ button to select "Select" or "ALL".

"Select" ..... Images within the card are selected one at a time and the quantity to print is specified.

"ALL" ..... The quantity of all frames within the card is specified. The quantity cannot be specified for individual frames.

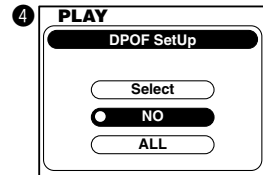
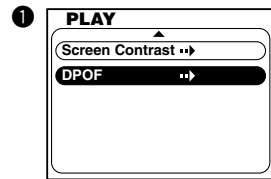

### Note:

\* If "NO" is selected and the SET button is pressed, the camera returns to the normal playback.

## For “Select”

- 5 Select “Select” and press the SET button.
- 6 Select the image using the ◀/▶ button and specify the quantity to print using the ▲/▼ button.

### Note:

\* The range that can be specified for “Quantity” is 1 – 99 for each image file.

- 7 Press the SET button.  
The camera will return to the screen of ②.
- 8 Press the ▼ button to select “Exit” and press the SET button.

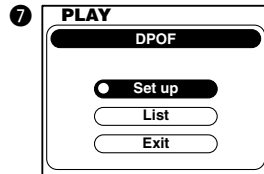
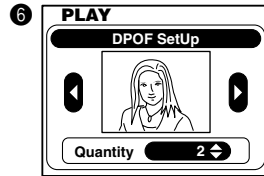
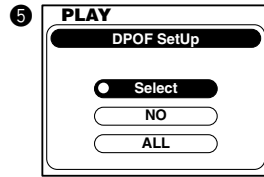

## For “ALL”

- 5 Select “ALL” and press the SET button.
- 6 Press the ▲/▼ button to specify the quantity to print. (“Select ALL” is selected.)

### Note:

\* The range that can be specified for “Quantity” is 1 – 99 for each image file.

\* If there are more than 100 images on the card, the message “You may select up to 100 pictures” will appear and the camera will display the “Select” screen.

\* If “Cancel” is selected using the ▶ button and the SET button is pressed, the camera returns to the screen of ②.

- 7 Press the SET button.  
The camera will return to the screen of ②.
- 8 Press the ▼ button to select “Exit” and press the SET button.

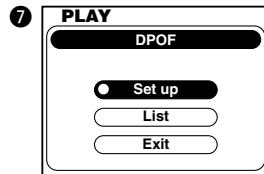
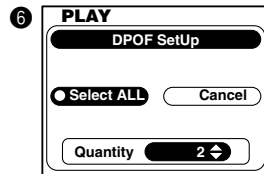
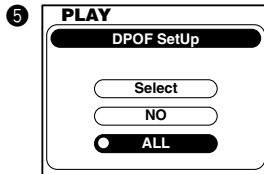

## Checking/determining images

The “File number” and “Quantity” are displayed in a list and the setting contents are checked.

- 1 Press the ▼ button to select “List”.
- 2 Press the SET button.  
The specified file number and quantity will be displayed in a list.
- 3 After checking the contents using the ▲/▼ button, press the ► button and select “Select”.
- 4 Press the SET button.  
The camera will return to the DPOF menu.
- 5 Press the SET button to exit the PLAY menu mode.

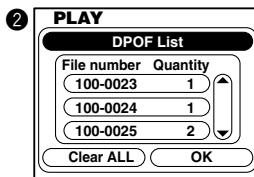

## Deleting images from the list (single frame/all frames)

Images not required to be printed can be deleted from the list (single frame/all frames).

- 1 Display the list screen.

### For single frame

- 2 Press the ▲/▼ button to select the image to delete.
- 3 Press the SET button.  
The image to delete and the delete confirmation screen will appear.
- 4 Press the ◀ button to select “YES” and press the SET button.  
The list screen with the deleted image removed will be displayed.

#### Note:

\* If “NO” is selected and the SET button is pressed, the deletion will be canceled and the camera will return to the list display.

- 5 Press the ▶ button to select “OK” and press the SET button.  
The camera will return to the DPOF menu.
- 6 Press the SET button to exit the PLAY menu mode.

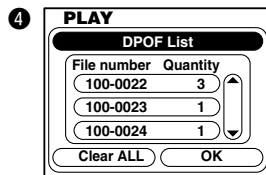

## For all frames

- 2 Press the ◀ button to select “Clear ALL” and press the SET button.  
The camera will return to the DPOF menu.
- 3 Press the SET button to exit the PLAY menu mode.



# Chapter 6 Advanced Operations

## Using the SET-UP Menu

By changing various items of the SET-UP menu, the camera can be set to your needs.

- 1 Set the main switch on the top of the camera to **SET**.

The LCD monitor will turn on and the SET-UP menu screen will appear.

- 2 Press the ▲/▼ button to select the desired menu.

The menu will change as shown below every time the ▲/▼ button is pressed.

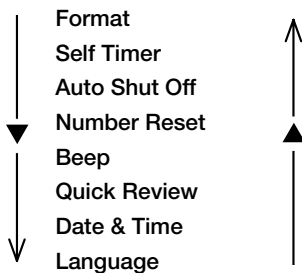

- 3 Press the ◀/▶ button to select the menu content.

**Note:**

\* To make a series of settings, repeat steps 2 and 3.

- 4 Set the main switch to a mode other than **SET** to exit the SET-UP menu mode.

**Note:**

\* The setting made are saved even when the power is turned off.

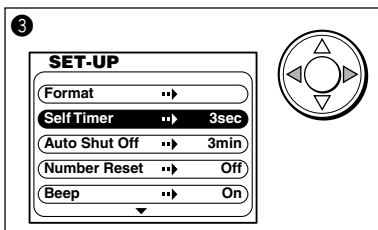
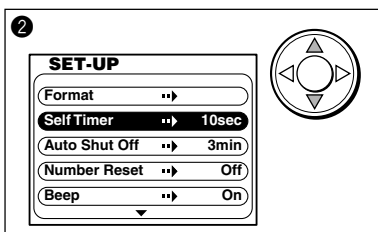
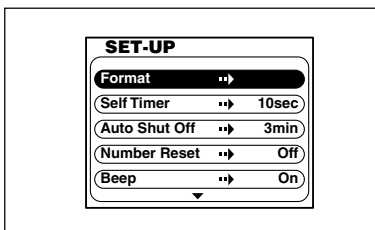
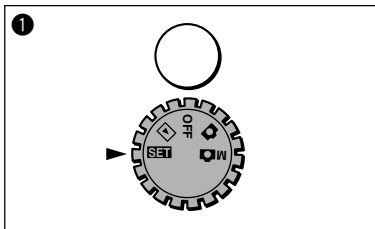

# Customizing the Camera

## Formatting the SD Memory Card/Multi-Media Card

- 1 Enter the SET-UP menu mode.  
"Format" is selected.
- 2 Press the **▶** button to enter the "Format" menu and press the **◀** button to select "NO".
- 3 Press the **◀** button to select "YES" and press the SET button.  
"Formatting..." message will appear.  
When formatting is completed, the screen of **1** will be displayed.

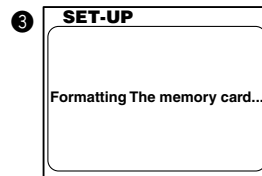
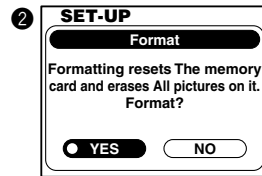
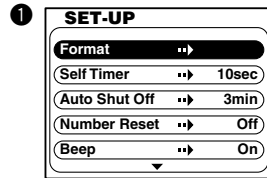

## Setting the Self Timer

The self-timer interval can be changed from 10 seconds (default setting) to 3 seconds.

- 1 Enter the SET-UP menu mode and press the **▲/▼** button to select "Self Timer".  
"10 sec" is selected.
- 2 Press the **◀/▶** button to select "3 sec".  
The setting will take effect at the time the menu selection is made.
- 3 Move to the next menu or set the main switch to a mode other than **SET** to exit the SET-UP menu mode.

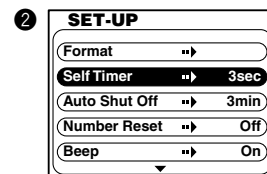
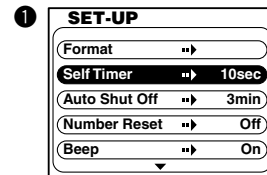

## Setting the auto shut-off time

The auto shut-off time can be changed from 3 minutes (default setting) to 10 minutes, or the function can be turned off.

- 1 Enter the SET-UP menu mode and press the ▲/▼ button to select “Auto Shut Off”.  
“3 min” is selected.
- 2 Press the ▲/▼ button to select “10 min” or “Off”.  
The setting will take effect at the time the menu selection is made.
- 3 Move to the next menu or set the main switch to a mode other than **SET** to exit the SET-UP menu mode.

**Note:**

\* Even if the selection is set to “Off”, the camera will automatically shut-off after several hours.

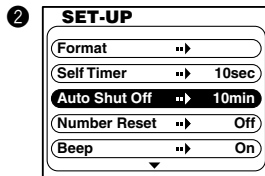
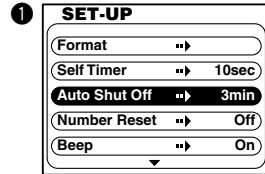

## Resetting the file number

The file number can be reset.

- 1 Enter the SET-UP menu mode and press the ▲/▼ button to select “Number Reset”.  
“Off” is selected.
- 2 Press the ► button to select “On”.  
The setting will take effect at the time the menu selection is made.
- 3 Move to the next menu or set the main switch to a mode other than **SET** to exit the SET-UP menu mode.

**Note:**

\* When factory shipped, the number reset is set to “Off” and continuous file no. are assigned as shown below.

xxxxx1.jpg xxxxxx2.jpg xxxxxx3.jpg . . . .

\* If number reset is set to “On”, and there are no images within the card that were recorded with this unit, images will be numbered from xxxxxx1.jpg. If there are images recorded with this unit, the number following the last file no. will be used.

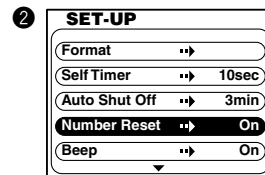
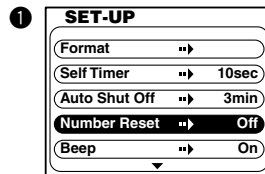





## Turning off the beep sound

The beep sound heard during warnings, etc. can be turned off.

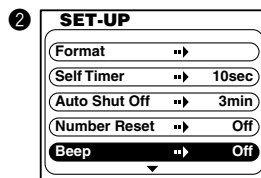
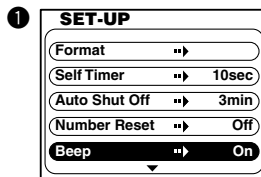
- 1 Enter the SET-UP menu mode and press the ▲/▼ button to select "Beep".  
"On" is selected.
- 2 Press the ◀/▶ button to select "Off".  
The setting will take effect at the time the menu selection is made.
- 3 Move to the next menu or set the main switch to a mode other than **SET** to exit the SET-UP menu mode.



## Setting the quick review

When setting the quick review on, the recorded image during  or **M** will be displayed for 3 seconds on the LCD monitor. (See page 27.)

- 1 Enter the SET-UP menu mode and press the ▲/▼ button to select "Quick Review".  
"Off" is selected.
- 2 Press the ▶ button to select "On".  
The setting will take effect at the time the menu selection is made.
- 3 Move to the next menu or set the main switch to a mode other than **SET** to exit the SET-UP menu mode.

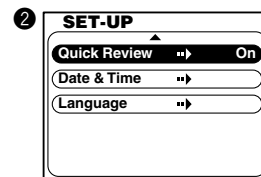
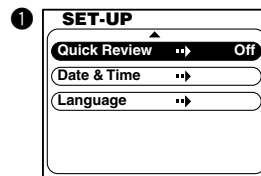

## Setting the date

- 1 Enter the SET-UP mode and press the ▲/▼ button to select “Date & Time”.
- 2 Press the ► button to enter the “Date & Time” menu.
- 3 For the setting, see “Adjusting the Menu Display Language and Time/Date” (page 20).
- 4 Press the SET button.  
The camera will return to the screen of ①.
- 5 Move to the next menu or set the main switch to a mode other than **SET** to exit the SET-UP menu mode.

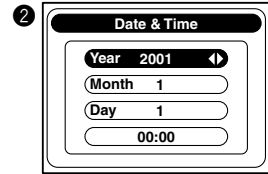
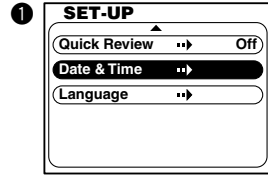

## Setting the language

- 1 Enter the SET-UP mode and press the ▲/▼ button to select “Language”.
- 2 Press the ► button to enter the “Language” menu.
- 3 Press the ▲/▼ button to select the desired language and press the SET button.  
The language confirmation screen will appear.
- 4 Press the ◀ button to select “はい” and press the SET button.  
The selected language will be confirmed and the camera will return to the screen of ①.
- 5 Move to the next menu or set the main switch to a mode other than **SET** to exit the SET-UP menu mode.

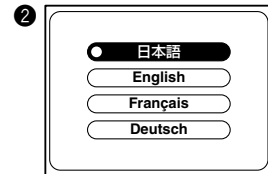
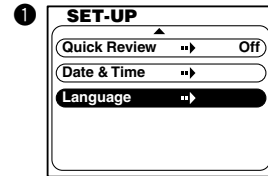

### Note:

\* Selecting “ いいえ ” and pressing the SET button will return you the screen of ②.

## Operating Environments

Images recorded with the camera can be transferred to a PC using the USB cable supplied.

### 1. Windows

OS: Preinstalled versions of Microsoft Windows 98, Windows 98SE, Windows 2000 Professional or Windows Me

Memory: 16MB or more of available RAM (32MB or more recommended)

Display: 32,000 colors or more, resolution of 640 × 480 pixels or higher

Others: CD-ROM drive, USB port (standard equipped)

### 2. Macintosh

OS: Mac OS 9.0/9.1/X (Version 10.0.1 or later)

CPU: PowerPC

Memory: 16MB or more of available RAM (32MB or more recommended)

Display: 32,000 colors or more, resolution of 640 × 480 pixels or higher

Others: CD-ROM drive, USB port (standard equipped)

## Using Windows

### Installing the included software (CD-ROM) and KD-200Z User's Guide

\* Be sure to install.

- 1 Turn on the PC power and start Windows.
- 2 Set the included CD-ROM in the CD-ROM drive.
- 3 Click the Start button and select "Run...".



The "Run" window will appear.

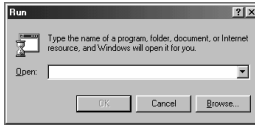

- 4 Enter "D:\install.exe" and click [OK].

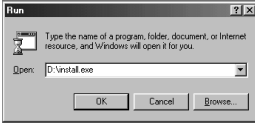

\* The above assumes that your CD-ROM is D. To check the CD-ROM drive letter of your PC, open My Computer and check the letter displayed on the CD-ROM drive icon.

- 5 Check to see that "QuickTime", "Adobe Acrobat Reader" and "KD-200Z User's Guide" in the "KONICA KD-200Z setup menu" are checked and click [OK].



\* Be sure to install "QuickTime", "Adobe Acrobat Reader" and "KD-200Z User's Guide".

- 6 Software checked in 5 will be installed in order. Follow the onscreen guidance to continue the installation.

Note: Clicking [Cancel] during the installation process will cancel installation. In this case, perform the installation again.

However, do not restart the PC until all the installations have been completed.

- 7 When all of the software checked in 5 have been installed, the "KD-200Z Setup Menu" screen will appear. Click [OK] to finish the installation process.

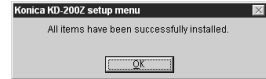



## Viewing the KD-200Z User's Guide

- 1 Double click the "KD-200Z User's Guide" icon on the desktop.
- 2 The KD-200Z User's Guide will be displayed.

# Installing the USB device driver

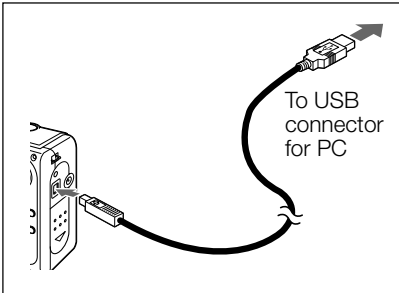
- 1 Turn on the PC power and start Windows.
- 2 Connect the camera and PC using the USB cable supplied.



- 3 Set the main switch on the top of the camera to  or .  
The “Add New Hardware Wizard” screen will appear.



- 4 Insert the CD-ROM supplied into the CD-ROM drive.
- 5 Click “Search for the best driver for your device. (Recommended.)” and then click “Next”.



- 6 Click “Specify a location:” and input “D:\”.



## Note:

- \* Here, the CD-ROM drive is assumed to be drive D. Use a different letter if appropriate.
- \* The INF file necessary for the install is located in “D:\”.
- \* When searching a different location, click “Browse”.

- 7 Click [Next].



- 8 Click [Next].



- 9 Click [Finish].



The USB device driver is now installed.



## Note:

- \* For Macintosh users, the USB device driver is not required.

# Transferring images

- ❶ Turn on the power of your PC.
- ❷ Connect the camera and PC using the USB cable supplied.
- ❸ Set the main switch on the top of the camera to , **M** ,  or **SET**.  
“PC” will appear on the status LCD.



- ❹ Double click “My Computer”.
- ❺ Double click the newly created “removable device (G)”.

**Note:**

\* This assumes that the new device is drive G. The drive letter may differ depending on the PC you are using.

- ❻ Double click the “DCIM” folder.
- ❼ Double click “100konic” to display the icon of the image file.

**Note:**

\* The first 3 digits of “100konic” vary depending on the existing directory of the card.

- ❽ Double click the file to display the image.  
To save, copy (drag and drop) the file to the desired location on the PC.

**Note:**

\* While the camera and PC is connected by the USB cable, the camera cannot be used for recording or playing back images.  
\* The camera cannot be connected to your PC if the card is not inserted.  
The camera power will turn off if the card is removed during PC connection.

# Using Macintosh

## Installing the Adobe Acrobat Reader

\* Be sure to install. And it is not necessary to install the Adobe Acrobat Reader for MacOSX users.

- 1 Turn on the power of your PC.
- 2 Set the included CD-ROM in the CD-ROM drive.

- 3 Double click the "Konica" icon.



- 4 Double click the "Adobe" icon.



- 5 Double click the "English" icon.



- 6 Double click the "Acrobat Reader Installer" icon.



- 7 Follow the instructions shown on the screen.

## Installing the KD-200Z User's Guide

\* Be sure to install.

- 1 Set the included CD-ROM in the CD-ROM drive.

- 2 Double click the "Konica" icon.



- 3 Double click the "Manual" folder.





- 4 Copy "GUIDE\_ENG" to a location of your choice.



- 5 Double click the copied "GUIDE\_ENG" to display the "KD-200Z User's Guide".

## Transferring images

- 1 Turn on the power of your PC.
- 2 Connect the camera and PC using the USB cable supplied.
- 3 Set the main switch on the top of the camera to , ,  or **SET**.  
“PC” will appear on the status LCD.



- 4 An “Undefined Name” icon will appear on the desktop.

- 5 Double click the “DCIM” folder.
- 6 Double click “100konic” to display the icon of the image file.

**Note:**

\* The first 3 digits of “100konic” vary depending on the existing directory of the card.

- 7 Double click the file to display the image.  
To save, copy (drag and drop) the file to the desired location on the Macintosh.

**Caution:**

Do not disconnect the USB cable/AC adapter (optional), or open the battery/card cover while the card access LED is on. Furthermore, do not format the SD Memory Card or Multi-Media Card using a PC. Data may become damaged.

## Notes

- Do not disconnect the USB cable/AC adapter (optional), or open the battery/card cover while the card access LED is on. Furthermore, do not format the SD Memory Card or Multi-Media Card using a PC. Data may become damaged.
- Image files can be copied to a hard disk or other media and deleted as necessary. For details, refer to the instruction manual operating system in use.  
Please note that Konica will not be responsible for any loss resulting from such operations.
- Always back up important data.
- The protect setting set with this camera is equivalent to the read-only attribute of a file. Please note that, if the attribute of a file is changed using a PC the protect setting set with the camera will be disabled.
- Images that have been altered or newly saved on an SD Memory Card/Multi-Media Card using a device other than this camera will not only play back on the camera but may cause the camera to malfunction when inserted.
- Do not change the file name of image data saved on an SD Memory Card/Multi-Media Card using a PC or save files other than image data taken by this camera.



### Using the AC adapter (optional: DR-AC2)

- Do not use the AC adapter with voltages other than the displayed power-supply voltage (100V AC – 240V AC).
- For countries with a different power plug shape, check with a travel agency, etc., and prepare a conversion adapter suitable for the power plug of the destination country in advance.

## Caring and storage

### Cleaning the camera

When cleaning the camera, do not use solvents such as benzene or paint thinner.

- Before cleaning, remove the batteries from the camera, or disconnect the power plug of the AC adapter from the wall outlet.
- The exterior casing surface consists of paint and printing. Wiping the casing with benzene or paint thinner may cause discoloration, or the paint or printing to be removed.
- When the camera becomes dirty, wipe off the dust with a soft, dry cloth. For stubborn dirt, dampen a cloth in diluted neutral detergent (kitchen detergent), wring thoroughly and wipe. When finished, wipe the camera with a dry cloth.
- When using a chemical cloth, follow the safety precautions of the product.

## After using the camera

If the camera is not to be used for a long period, remove the batteries and ensure that the power plug of the AC adapter is disconnected from the wall outlet.

- Leaving the batteries inside the camera for a long time may cause the battery fluid to leak, resulting in malfunction of the unit.
- When storing, keep both camera and batteries in cool place with low humidity and under constant temperature as much as possible.

Recommended temperature: 15°C – 25°C

Recommended humidity: 40% – 60%

## About the SD Memory Card/Multi-Media Card

Handling

- Do not bend or apply excessive force.
- Do not store the card in places with high humidity, dusty places or where static electricity or electromagnetic fields are likely to occur.
- Keep dust, water and foreign objects away from the terminal section.

## About image data

- Use a PC to delete images and files recorded with other models.
- The recorded data may be lost when you or a third part misuses the SD Memory Card/Multi-Media Card, if the card is affected by strong static electricity or electrical shock, or during card repair or malfunction.



Konica will not be responsible in any way for the loss of recorded data or the consequences of such loss.

## About the LCD monitor

- The LCD monitor has been developed using high-precision engineering. Although the percentage of active pixels is more than 99.98%, there may be missing or constantly lit pixels.
- When using the LCD monitor in a cold location, the screen may appear darker than normal immediately after starting use. The screen will return to normal brightness as the internal temperature of the camera rises.
- When the LCD monitor becomes dirty with finger prints or dust, wipe with a soft, dry cloth.

# Troubleshooting

- If inspecting the following items does not cure the problem, the dealer from whom you purchased the camera or a Konica Service Station (page 79).

	Symptom	Check	page
Power	The power will not turn on	• Batteries are depleted.	15
		• Batteries are not inserted with incorrect polarity.	16
• AC adapter is not connected properly.		17	
	The power will suddenly turn off after turning it on	• Batteries are depleted.	15
		• The camera is being used at low temperature.	77
• New nickel-hydrogen battery is being used.		11	
Recording	Images cannot be recorded even when pressing the shutter button	• Main switch is not set to  or  .	23, 36
		• Recordable SD Memory Card/Multi-Media Card is not inserted.	63
		• SD Memory Card is write-protected.	10
		• Maximum number of images has already been recorded. → Delete images that are no longer required.	28, 50
		• The camera is set to self-timer.	34
		• Flash is being charged. → Wait for a while.	22
		The LCD monitor or image is not clear	• The LCD monitor brightness adjustment is not correct.
• LCD monitor is dirty with fingerprints or dust.	74		
Focus cannot be adjusted	• The subject is not in the center.	25	
	• The subject is difficult to focus.	33	
	• The front cover glass is dirty.	73	
	• The recording mode and the distance between the camera and subject are not correct.	22	
Flash does not work	• The flash mode is set to "Flash Off".	31	
Image colors are not natural	• Image was taken under conditions where white balance could not be adjusted.	41	
Battery dies after very little recording	• AA alkaline batteries are being used.	17	

	Symptom	Check	page
Playback	Cannot play back	• Main switch is not set to  .	46
		• Images were continuously shot.	26
		• SD Memory Card/Multi-Media Card recorded with images is not inserted.	46
		• All images on the SD Memory Card/Multi-Media Card have been deleted.	51, 63
	Battery dies after very little playback	• AA alkaline batteries are being used.	17
Others	Correct date is not displayed when turning on power	• The backup time during battery replacement is about 15 minutes. The date must be set again if this limit has been exceeded.	20
	Cannot transfer images to PC	• Camera is not correctly connected to the PC. • The main switch of the camera is set to OFF.	67 70, 71

## Error message

- If the number of remaining frames on the status LCD displays “Err” and all status LED flash an error has occurred. In this case, perform the following procedure.

- (1) Set the main switch to OFF.

Set the main switch to other than OFF. If camera functions are not restored:

- (2) If using the AC adapter, disconnect it. (See page 17.)
- (3) Remove all batteries. (See page 16.)
- (4) Install new batteries. (See page 16.)

If the error persists even after performing the above procedures, contact the dealer from whom you purchased the camera or a Konica Service Station.

For inquiries concerning repair, handling and care, contact the dealer from whom you purchased the camera.

# Main specifications

Type	: Digital still camera
Recording medium	: SD Memory Card/Multi-Media Card
Number of Recordable images	: Super fine 1600 × 1200 pixels (approx. 17 images/8MB SD Memory Card) Fine 1280 × 960 pixels (approx. 26 images/8MB SD Memory Card) Economy 640 × 480 pixels (approx. 60 images/8MB SD Memory Card) Movie (1 movie = Max. of 15 sec.) 320 × 240 pixels (approx. 2 movies/8MB SD Memory Card) 160 × 120 pixels (approx. 8 movies/8MB SD Memory Card)
Recording method	: JPEG standard (Exif ver 2.1) DPOF compatible (*1)
Image format	: Design rule for Camera File System standard (DCF) compatible (*2)
Imaging elements	: 1/2.7 inch, 2.11 million pixel RGB CCD (active pixels: 2.02 million pixels)
Lens	: f=5.4 ~ 16.2mm, F 2.8(W) ~ 4.6(T) (Equivalent to f=35 ~ 105mm by 35mm film camera conversion)
Focus adjustment	: Auto focus
Recording range	: 0.25m ~ ∞ (during macro recording mode: 0.25m ~ 0.8m) (Normal recording: 0.8m ~ ∞)
Exposure control	: Programmed AE
Photometry	: Center weighted light reading (normal setting), spot reading
White balance	: Auto, daylight, incandescent lighting, flash, fluorescent lighting
Shutter speed	: Mechanical shutter, CCD electronic shutter 1/8 ~ 1/2000 sec (during slow shutter ON: 2 ~ 1/2000 sec)
Viewfinder	: Optical real-image type viewfinder
Flash	: Internal auto lighting flash Flash recording range: WIDE: 0.8 ~ 3.0m TELE: 0.8 ~ 2.0m Red-eye reduction/AUTO/ON/OFF available
Recording modes	: Recording modes: Single shooting/Self-timer (10 sec/3 sec)/Macro recording/Long distance/Night view portrait/Back-and-white/Digital zoom (×1.5, ×2.0)/Movie (320 × 240, 160 × 120)
LCD monitor	: 1.5 inch low-temperature polysilicon TFT color LCD monitor
Playback	: Single frame, close-up playback (×2), movie playback, index playback, slideshow
Deletion	: Single frame/all frames/format
LED display	: Self-timer LED, viewfinder LED, card access LED
Buzzer	: Various warnings during recording
Auto-date function	: Date and time recorded
Power supply	: CR-V3 lithium battery (1 unit), AA nickel-hydrogen batteries (2 units), AA alkaline batteries (2 units), or AC adapter (DC 3V)
I/O terminals	: USB terminal, AC adapter jack
Operating temperature	: 5°C ~ 45°C (Humidity: 20% ~ 80%RH)
Size (W × H × D)	: 100 × 61.5 × 30.5mm (excl. protrusions)
Weight	: Approx. 170g (excl. batteries, SD Memory Card)
Accessories	: SD Memory Card (8MB), CR-V3 lithium battery, strap, CD-ROM, USB cable, quick guide, warranty, Konica Card
Optional accessories	: AC adapter, exclusive soft case

## Battery life guide (reference)

	Recording (LCD monitor on)	Recording (LCD monitor off)	Continuous playback
CR-V3 lithium battery	About 500 images	About 1,250 images	About 300 minutes
AA nickel-hydrogen batteries	About 150 images	About 300 images	About 75 minutes

\* Under Konica test conditions (room temperature, Super Fine mode, 50% flash, continuous recording at 20 second interval, and one zoom operation in single direction)

Note: Battery life varies depending on the brand and grade.

\*1: DPOF (Digital Print Order Format) specified by Canon, Inc., Kodak Co., Ltd., Fuji Photo Film Co., Ltd., and Matsushita Electric Industrial Co., Ltd. is a standard for recording specified information such as the images or quantity to print from the images taken by a digital camera on a recording medium.

\*2: DCF (Design rule for Camera File system) is a standard by JEITA mainly for the purpose of simplifying the use of image files taken by digital cameras with other related devices.

# Warranty and After-sales Service

For repair, handling and care, first consult the dealer from whom you purchased the camera.

## Warranty (separately attached)

Before accepting the warranty card, please make sure that the date of purchase and dealer of purchase and the dealer's details have been completed. After reading the warranty, keep it in a safe place.

Warranty period (main unit): 1 year from the date of purchase

## During the warranty period

Repairs will be made by the dealer from whom you purchased the camera according to the contents of the warranty. For repair, take the product and the warranty to the dealer from whom you purchased the camera.

## Outside the warranty period

Repairable products can be repaired for a charge upon request. However, the minimum holding period of performance parts for repairing digital still cameras is 8 years after termination of production.

**Note: Performance parts for repair are parts necessary to maintain the functions of the product.**

## When requesting service

If symptoms persist after having checked the table on pages 75 and 76, disconnect the power supply and contact the dealer from whom you purchased the camera.

**Note: Transportation cost for taking/bringing back the product to/from repair, shipping cost or carrying charges are at the customer's expense. When shipping the product, pack the unit appropriately and use shipping method such as registered mail or express mail to prevent loss of the product.**

## FCC Statement:

Declaration of Conformity

Responsible party: KONICA PHOTO IMAGING

Address: 725 Darlington Avenue Mahwah, NJ 07430, U.S.A.

Telephone number: (201) 574-4000

This device complies with Part 15 of the FCC Rules. Operation is subject to the following two conditions:

(1) this device may not cause harmful interference and (2) this device must accept any interference received, including interference that may cause undesired operation.

This equipment has been tested and found to comply with the limits for a class B digital device, pursuant to Part 15 of the FCC Rules. These limits are designed to provide reasonable protection against harmful interference in a residential installation. This equipment generates, uses and can radiate radio frequency energy and, if not installed and used in accordance with the instructions, may cause harmful interference to radio communications. However, there is no guarantee that interference will not occur in a particular installation. If this equipment does cause harmful interference to radio or television reception, which can be determined by turning the equipment off and on, the user is encouraged to try to correct the interference by one or more of the following measures:

- Reorient or relocate the receiving antenna.
- Increase the separation between the equipment and receiver.
- Connect the equipment into an outlet on a circuit different from that to which the receiver is connected.
- Consult the dealer or an experienced radio/TV technician for help.
- Shielded cables must be used for this equipment to comply with the relevant FCC regulation.
- Power requirement is DC 5V  $\pm$  10% and 2 A max. Use only listed certified power supply adapter.
- The user is cautioned that changes and modifications made to the equipment without approval of the manufacturer could void the user's authority to operate this equipment.

 Tested To Comply  
With FCC Standards  
FOR HOME OR OFFICE USE

### ENGLISH

However, note that operation of this unit near a radio or television receiver could possibly cause radio disturbance.

### CANADA ONLY

Industry Canada's Compliance Statement:

This Class B digital apparatus complies with Canadian ICES-003.

Cet appareil numérique de la classe B est conforme à la norme NMB-003 du Canada

**Konica**